

Signal Tower

Complete Operation Manual
[Type: LA6]

PATLITE Corporation

Table of Contents

1. Introduction	3
1.1. Safety Precautions	3
1.2. For safe application, observe the following:	3
1.3. About this Product	4
2. Model Number Configuration	5
3. Part Names and Dimensions	6
3.1. Outer Appearance List	6
3.2. Part Names and Outer Appearance	7
3.3. Attachment Angle Part Names and Dimensions	9
4. Mounting Direction	10
5. Wiring	13
5.1. Wiring Examples	14
5.1.1. Connecting to Relay Contacts [DC24V Type]	15
5.1.2. Connecting to a PLC (NPN) [DC 24V Type]	15
5.1.3. Connecting to a PLC (PNP) [DC 24V Type]	16
5.1.4. Connecting to Relay Contacts [AC 100 -240V Type]	17
5.1.5. Connecting to a PLC (NPN) [AC 100 -240V Type]	17
5.2. Current Capacity	18
5.2.1. Contact Capacity [DC 24V Type]	18
5.2.2. Contact Capacity [AC 100 - 240V Type]	18
6. Operating Directions	19
6.1. "Signal Tower" mode	19
6.2. "Smart Mode"	20
6.2.1. "Time-trigger" mode	20
6.2.2. "Pulse-trigger" mode	22
6.2.3. "Single-display" mode	24
6.3. Multi-function Button Operation	26
6.4. Factory Default Data	30
7. Changing Data	37
8. Time Chart	38
8.1. Basic Signal Input Time Chart	38
8.2. Trigger Input Signal Time Chart	38
9. Before Requesting Repair	39
10. Replacement Parts	40
11. Specifications	41

1. Introduction





Thank you very much for purchasing our PATLITE product. Please read this comprehensive operation manual thoroughly before use. In addition, please store this manual for future reference when performing maintenance, repairs or inspections. When performing maintenance and repairs, etc., please be sure to reread this book. If there are any questions concerning this product, please refer to the information on the last page to ask your nearest PATLITE Sales Representative.

1.1. Safety Precautions

The following symbols classifies the following precautions into two categories and explains the level of harm inflicted when caution is disregarded while using this product.

Contrary to Warnings and Cautions indicated in this document, product failure due to mishandling, disassembly, modifications or natural disasters, etc. is not covered by any Warranty. Moreover, avoid any applications outside those indicated in this document.

1.2. For safe application, observe the following:

 WARNING	Indicates an imminently dangerous condition: Failure to follow the instructions may lead to death or serious injury.
 CAUTION	Indicates a potentially dangerous condition: Failure to follow the instructions may lead to slight injury or property damage.
	Indicates something to observe before using this product. The disregard to this indication may lead to product malfunction or failure.
	Indicates a notice regarding supplementary information or convenient explanation of this product.

WARNING

- Prior to installation and wiring, ensure the power is disconnected and the Main Unit is turned off. Failure to comply may result in electric shock.
- Be sure the wiring is correct. If an error is made in wiring, the internal circuit will be damaged and may cause a fire.
- Be sure the power source is in the voltage tolerance when using it. Failure to comply may result in malfunction or fire.
- Do not modify or disassemble the product. Possibility of fire or electric shock may occur. Refer to the "Troubleshooting" section, or ask for technical consultation from the addresses indicated in this manual for repair, etc. of this product.
- Be sure to request the installation and wiring be performed by a professional contractor. There is a risk of an electric shock, fire, or falling.
- When the product is mounted onto equipment, do not use it as leverage to climb onto the equipment, etc. Failure to comply will result in falling from a high place, or damage to the product.

CAUTION

- Avoid long exposure to the alarm sound from a close distance. Failure to observe this may lead from irritation to permanent damage to the ears.
- Do not install the product in a location where vibrations exceeding the specifications exist. Failure to comply may result in the prevention of the product detaching and falling, causing injury to a passer-by, etc.
- Do not remove parts beyond those designed to be removed from this product. Failure to comply will result in damage to the product.

Flashing/Alarm Type

- By all means, do not apply voltage to the "Flashing/Pulse Enable Common" line (Refer to "5.1. Wiring Examples" on page 14). Failure to comply may result in damage to the product.

AC 100 - 240V Type

- Do not apply voltage, or connect the source line to the signal line. Failure to comply may result in damage to the product.

LA6 Signal Tower Complete Operation Manual

Please

- Connect an external fuse between the power supply circuit and the internal circuit to protect the Main Unit.
- Do not use in an environment exposed to strong radio waves or inductance noise. Failure to comply will result in malfunction due to the influence of noise.
- Do not use in an environment where corrosive gas is present. Possible cause of failure may occur.
- Discharge any static electricity from the body before handling static sensitive parts, such as the Micro-USB Cable. To prevent damage from static electricity, touch hands or other body parts to metals or an earth ground to discharge the body from static charge.
- Do not lose parts, such as the Head Cover, when removing while working with the product.
- When this product is used for security purposes, it should be inspected daily and it is recommended this product should be used together with other security products in case a malfunction should occur.
- Do not remove parts, other than ones indicated as removable on the product.
- Do not modify or change the product in any way.
- The specific parts written in this book should be used for replacement at any cost.
- By following the attachment and the handling method written in this book, this product can be used to comply for a Type1 Enclosure. (For UL Standard Compliance)
- Use a "Class 2" power source which complies with UL1310. (For UL Standard Compliance)

[B] Flashing/Alarm Type]

- The alarm sound is unidirectional, therefore it is most easily audible in the direction from the source. Position the signal tower so that the alarm sound is facing in the desired sound direction.
- Sound pressure may decrease if the alarm is used in an environment which has water, steam, etc., nearby.

[D] DC24V Type]

- Use a "class 2" power supply specified in the guidelines under UL1310. (UL Standardized conditions)

Note

- This complete operation manual should be stored in a safe location and it is recommended to be periodically read before maintenance is performed.

1.3. About this Product

This product is designed to display and announce information with LED lighting and alarm* functions for the operation state of major applications, such as equipment status, to indicate elapsed time, factory automation applications, waiting in line at institutions, such as stores and banks, etc.

This product can be controlled with signal inputs to drive the Alarm and signal towers like a standard Signal Tower in the "Signal Tower Mode", but also has a new function, the "Smart Mode." In the "Smart Mode", the customer can use the binary input to create a diverse display of light flashing controls, like a level meter, dimming or chase-light controls, etc., with the setup of programmed data.

* Only for Flashing/Alarm Type

2. Model Number Configuration

	Model	LED Tiers	Rated Voltage	Mounting/Wiring Installation	Body Color	Flashing/Alarm (Option)	Color
Model Number	LA6-	↓	↓	↓	↓	↓	-RYGBC

3 or **5** Tiers

D 24V DC

WJ Direct mount with cable connection
TN Direct mount with Screwless Terminal Block connection
LJ Mounting angle and steel pole with cable

W Off-white
U Silver ※

※ **U** is not available for **LJ**.

B With Flashing/Alarm
N Without Flashing/Alarm

Color for each tier in Signal Tower Mode (Factory default setting).
 R (Red) · Y (Amber) · G (Green) · B (Blue) · C (White)
 (The LED light color for each tier can be changed after purchase.)

	Model	LED Tiers	Rated Voltage	Mounting/Wiring Installation	Body Color	Flashing/Alarm (Option)	Color
Model Number	LA6-	↓	↓	↓	↓	↓	-RYGBC

5 Tiers

A 100V ~ 240V AC

WJ Direct mount with cable connection

W Off-white

B With Flashing/Alarm

Color for each tier in Signal Tower Mode (Factory default setting).
 R (Red) · Y (Amber) · G (Green) · B (Blue) · C (White)
 (The LED light color for each tier can be changed after purchase.)

Model Number Example

LA6-3DWJWN-RYG

•LED 3 Tiers •Direct mount with cable connection •Off-white •Without Flashing/Alarm •(From top to bottom) Red • Amber • Green

LA6-5DTNUB-RYGBC

•LED 5 Tiers •Direct mount with Screwless Terminal Block connection •Silver •With Flashing/Alarm •(From top to bottom) Red • Amber • Green • Blue • White

3. Part Names and Dimensions

3.1. Outer Appearance List

The full product appearance is indicated according to its model number. Refer to the model numbers as a reference to its appearance.

Number of Lens Tiers	3 Lens Tiers						5 Lens Tiers						
Rated Voltage	D											A	
Mounting/Wiring Installation	WJ	TN	LJ	WJ	TN	LJ	WJ	TN	LJ	WJ	TN	LJ	WJ
Body Color	W Off-white / U Silver (Not available for the LJ Type)											W	
Flashing/Alarm (Option)	B	N	B	N	B	N	B	N	B	N	B	N	B

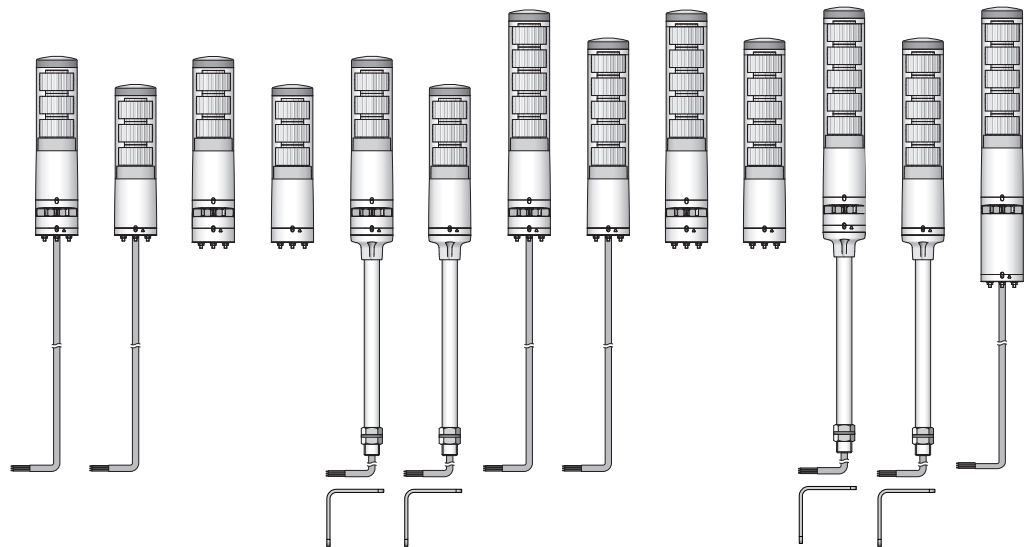

3.2. Part Names and Outer Appearance

Each figure contains 5 lens tiers, with Flashing/Alarm functions. For 3 lens tiers, the outer lens height will be shorter. Also, for models not including the Flashing/Alarm functions, the product will not include an alarm unit.

■ **WJ** Direct mount with cable connection

■ **TN** Direct mount with Screwless Terminal Block connection

D 24V DC Type

D 24V DC Type

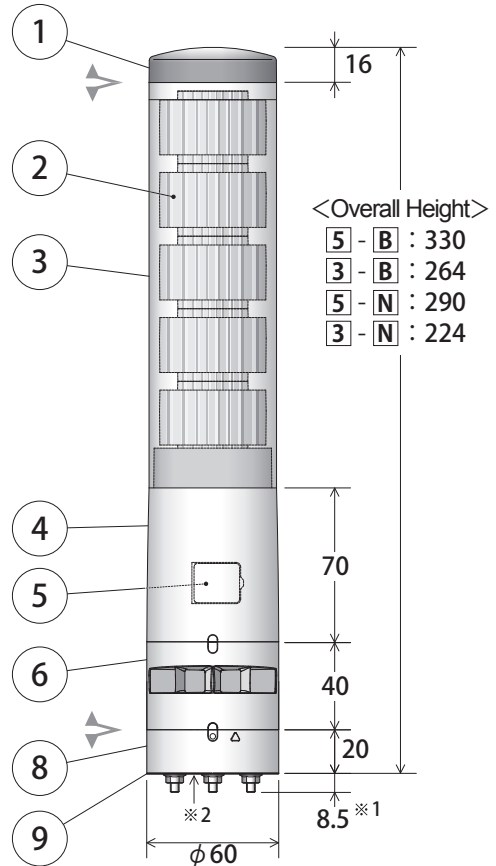
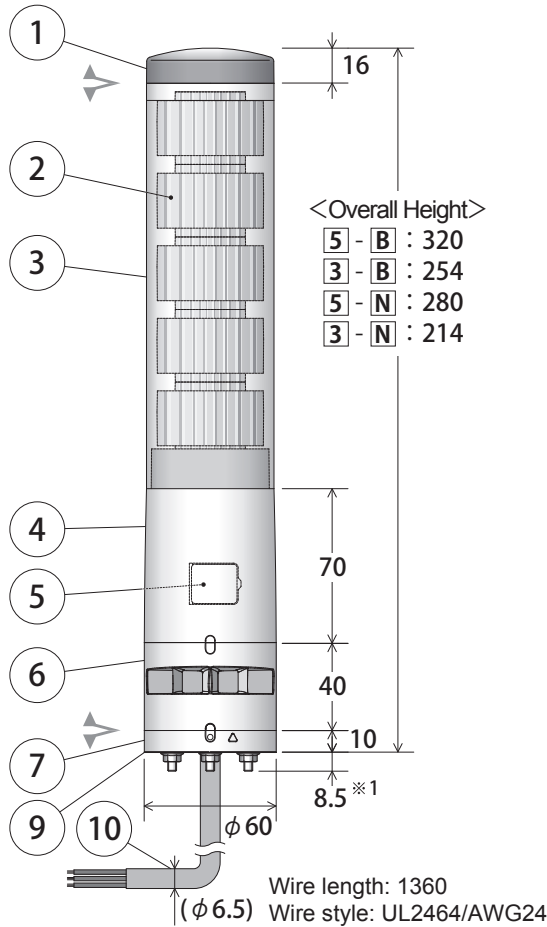

(Unit:mm)

14 Accessory Assembly WJ TN	
Screw (M4x20)	3pcs.
Flanged nut (M4)	3pcs.

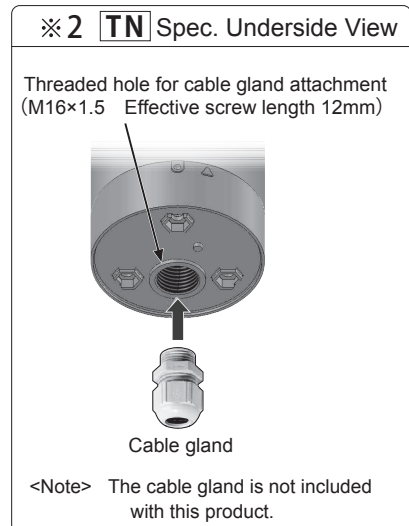

LA6 Signal Tower Complete Operation Manual

■ **LJ** Steel pole with mounting angle and cable

D 24V DC Type

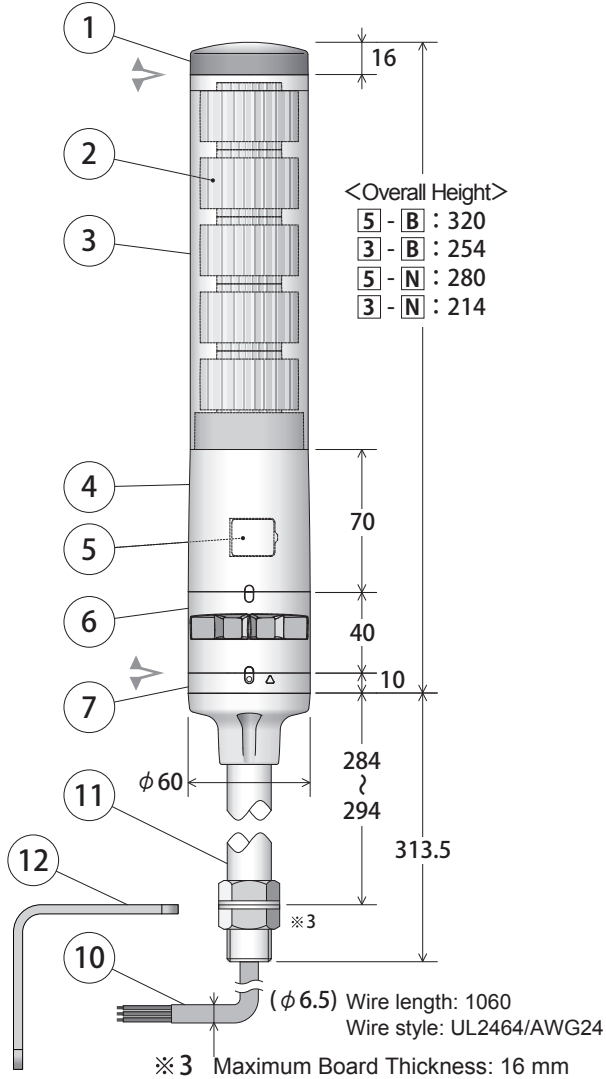

■ **WJ** Direct mount with cable connection

A 100V - 240V AC Type

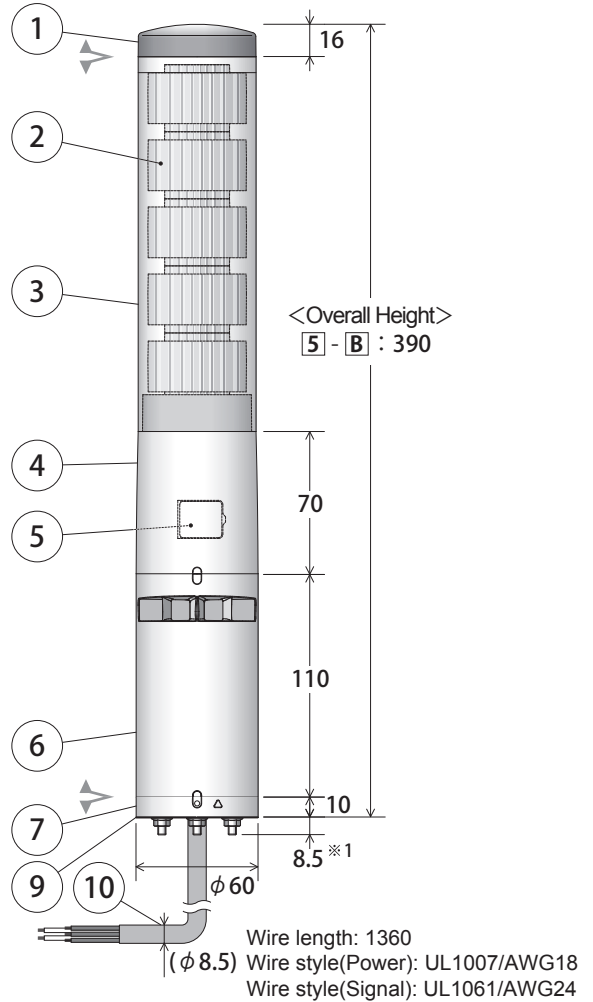

Number	Name	Material	Number	Name	Material
1	Head Cover	ABS	8	Terminal Block Bracket	ABS
2	Lens	PMMA	9	Waterproof Packing	Urethane Foam
3	Outer Lens	PC	10	Cable	PVC
4	Body	ABS	11	Pole	Steel Pipe
5	USB Cover	ABS	12	Mounting Angle	Steel Plate
6	Buzzer Case	ABS	13	Multi-function Button	ABS
7	Direct-mount Bracket	ABS	14	Accessory Assembly	Steel

(Note) ➤ The arrow mark (stackable mark) shows the part of the Main Unit (upper portion of bracket) which can be removed.
 Do not disassemble any parts other than the parts indicated above.

13 Multi-function Button (Remove Head Cover)

Remove the head cover by turning it to the left to release it from the locked position. (To re-assemble, perform the steps in the reverse order.)

(Note) This connector is not used.

5 USB Cover (Detailed Parts)

(Cover in opened position)

Micro USB connector (Micro-B Female)

(Note) - To open the USB Cover, insert a minus driver (blade-edge width of 3 mm, thickness of 0.5 mm or less) in the indented part and lightly pry it open.
 (Use an object made of ceramic to avoid scratching or damaging the Body.)
 - Ensure the USB cover is closed at all times. If not securely closed, the waterproof performance will decrease.

3.3. Attachment Angle Part Names and Dimensions

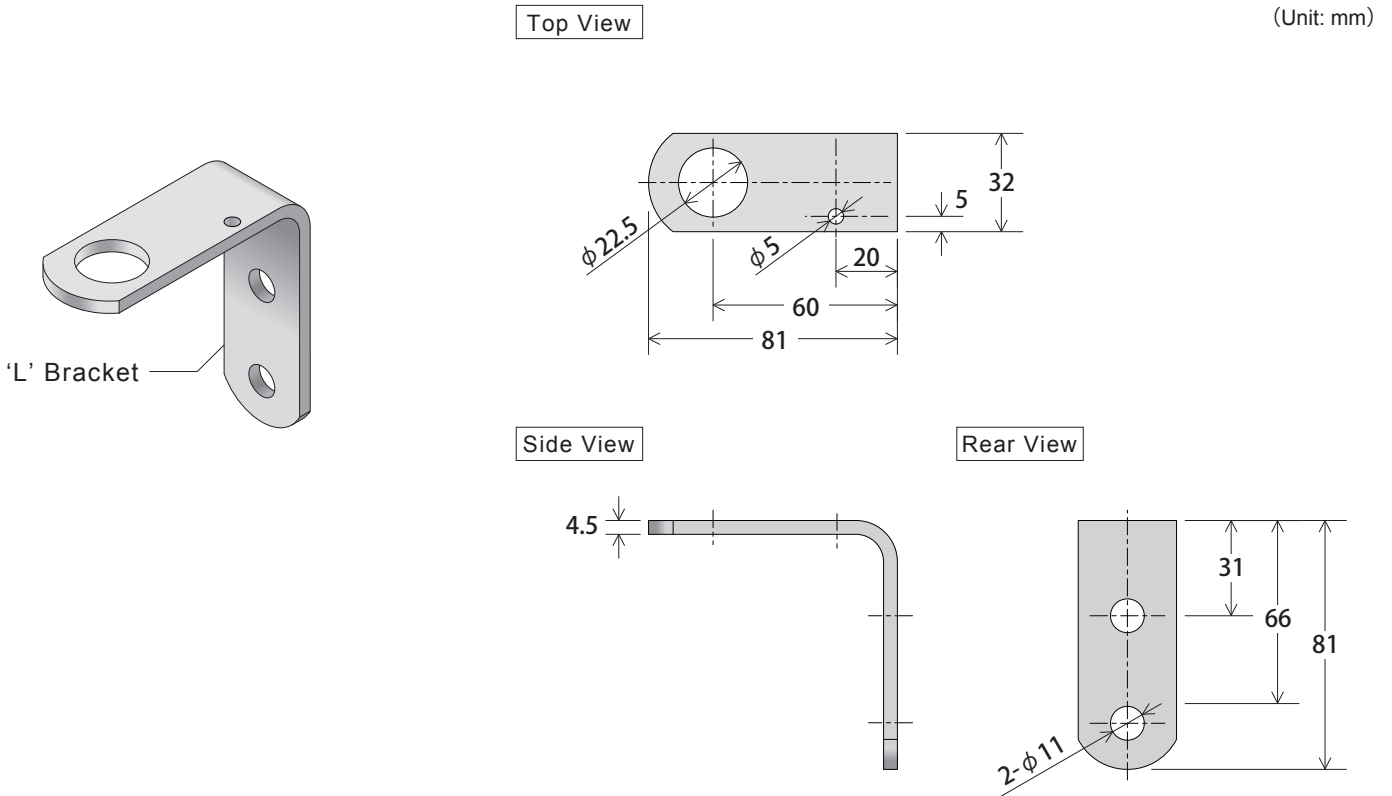

4. Mounting Direction

⚠ WARNING

- The product should be turned off and the power supply disconnected prior to installation. Failure to comply may result in electric shock.

⚠ CAUTION

- The clamping surface should be sufficient enough to tolerate the weight and surface of the product. Do not use the product in a place where vibrations exceeds the specifications. Failure to comply may result in the product detaching and falling, causing injury to passers-by, etc.
- Only install the signal tower in an upright or inverted position. Failure to comply may result in the product detaching and falling, causing injury to passers-by, etc.
- Use a soft cloth, etc., dampened with water to wipe the main unit. If wiped with chemicals outside water (thinner, benzene, gasoline, oil, etc.), product damage may occur.
- Do not disassemble this product beyond it's usable parts (refer to "3.2 Part Names and Outer Appearance" on page 7). Failure to comply may result in product breakage due to disassembly.

[D] DC24V Type

- This equipment complies with FCC regulation part 15 for class A digital products, and applies to the following restrictions. These restrictions are limited to cases where this equipment is operated in a business district, and it is designed to take the relevant protective measures against electromagnetic noise hindrance.
- This product must not be used in residential areas.

1 Check the installation location for the product before mounting

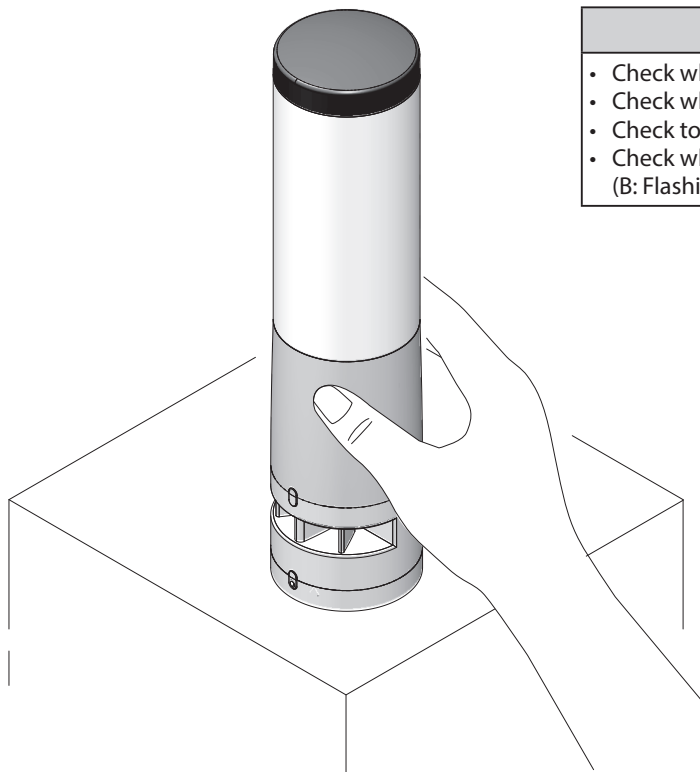

Note

- Check whether it interferes with any other objects.
- Check whether wiring can be easily done.
- Check to be sure the USB Cover can be opened and closed.
- Check whether the alarm direction is correctly suitable.
(B: Flashing/Alarm Type)

2 **Marking holes for wiring and installation**

Use the "Installation Template" pattern (Refer to the Instruction Manual [Maintenance Version]), and mark holes with a punch, etc.

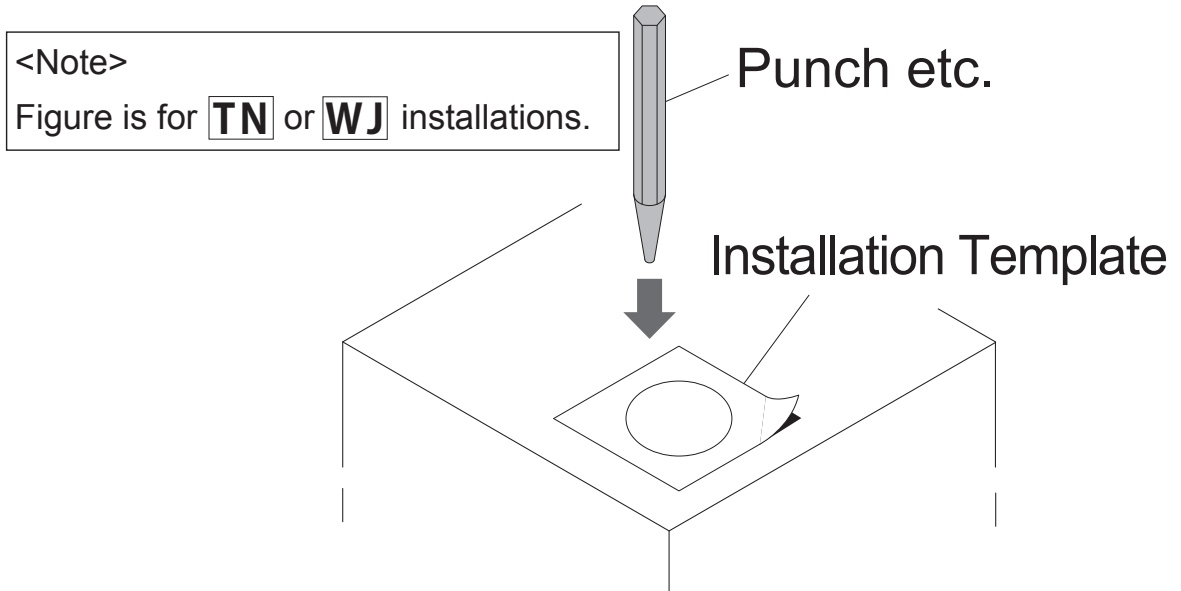

3 **Making holes for wiring and installation**

Use a drill, etc., to make holes for installation and wiring.

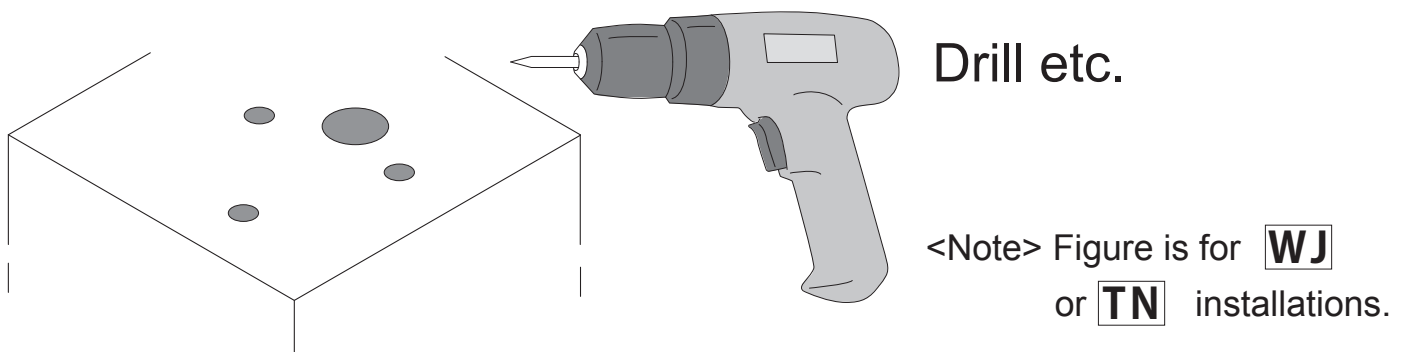

Note

- To continue from procedure 3, refer to the model type (WJ), (TN), (LJ) for procedure 4 to continue the mounting and wiring installation.

LA6 Signal Tower Complete Operation Manual

Model WJ Direct mount and Cable

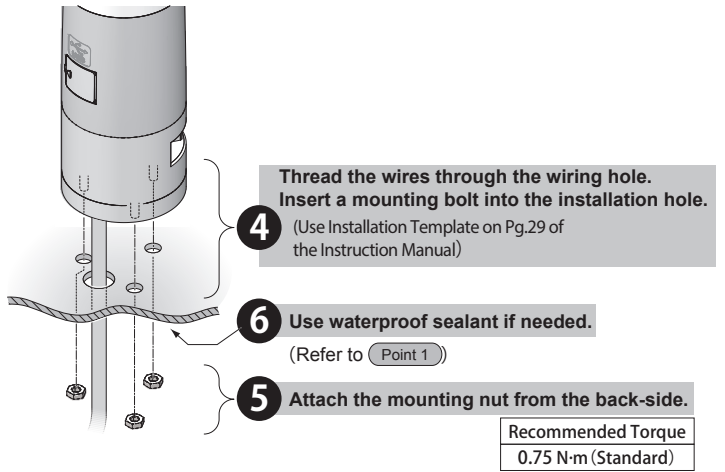

Point 1

If the installed environment exposes water, etc., to the under-side of the mounting surface, be sure to use sealant on the mounting and distribution holes.

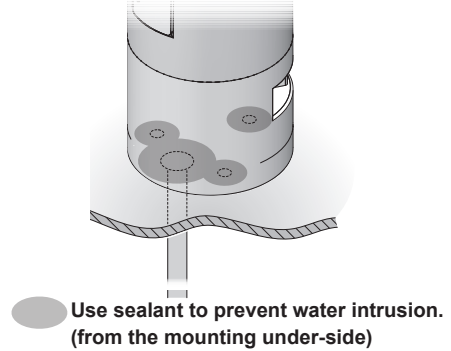

Model LJ Steel pole with Mounting angle and Cable

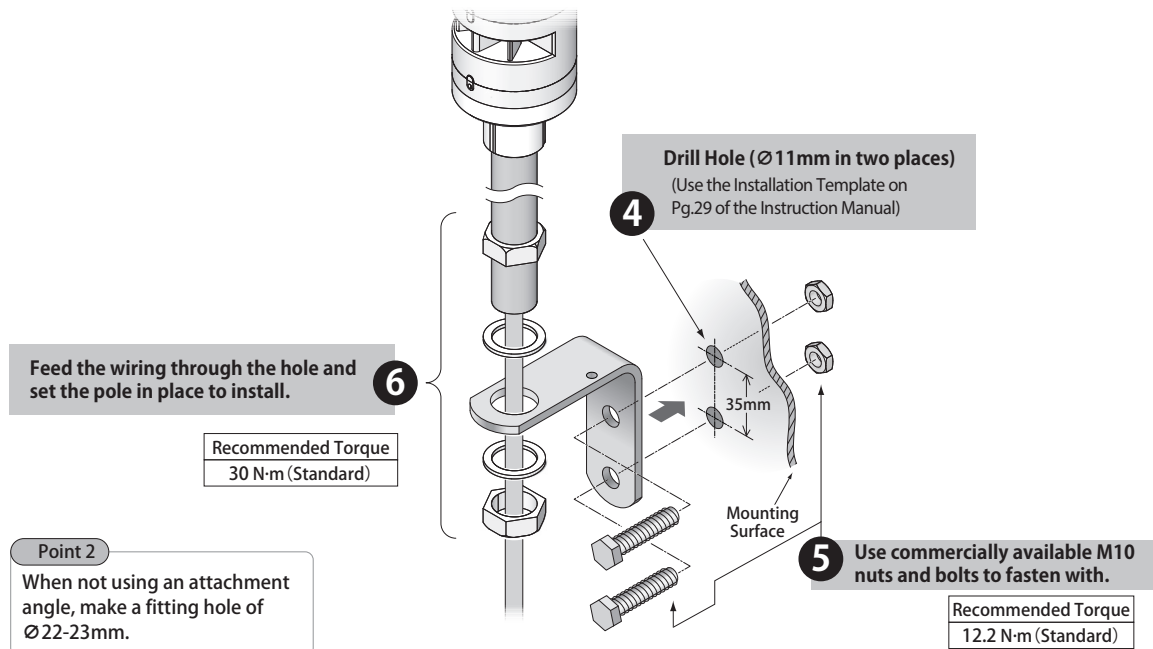

Model TN Direct Mount/Screwless Terminal Block

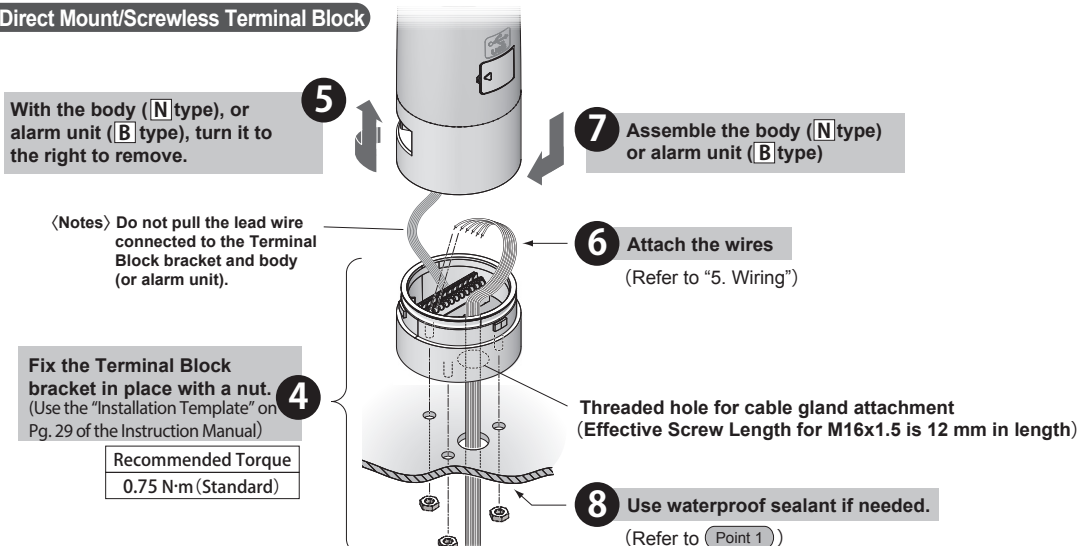

5. Wiring

WARNING

- The power supply should be turned off prior to wiring, at any cost. Failure to comply may result in electric shock.
- Be sure the wiring is correct. If an error is made in wiring, the internal circuit will be damaged and may cause a fire.
- When transferring data via USB connection, do not allow the supply voltage from this product to contact with the personal computer, or it's peripheral devices. Failure to comply will result in product damage due to combustion or fire.
 - As an example, if the positive power terminal is connected to ground and the personal computer, FG (housing), which in turn, makes a connection with this product via the USB connection, it should not be grounded because of the reverse polarity. There are some personal computers which have the USB port connector and negative terminal of the personal computer in contact with the FG (housing). Personal computers with such USB connections made, should have the FG (housing) of the personal computer and the negative terminal of the USB port of the product connected. If the case is where the personal computer has the metal part as the positive grounding of the supplied power source to the product, the product will have a 24V potential applied to the negative terminal of the USB port of the product, thus will lead to damage of the product by burning.

CAUTION

- Strip 9mm (± 1 mm) of wire insulation from the wire to insert it in the Terminal Buss. If longer than this, it may result in electric shock or short-circuiting. (For (TN) Direct Mount/ Terminal Buss)
 - Wire the product so that the lead wire does not protrude from the terminal. Failure to comply may result in electric shock or short-circuiting. (For (TN) Direct Mount/ Terminal Buss)
 - It is not necessary to connect to an external lead for tiers not used. When an extra lead is not connected, it should be individually insulated with electrical tape or something similar. Failure to comply may result in electric shock or short-circuiting.
 - Do not pull the lead wire or push it inside the body. Failure to comply may result in product damage or short-circuiting.
 - If wiring is extended beyond its factory length, a relevance in the length of the wire and wire gauge will cause a voltage drop.
- [B] Flashing/Alarm Type]
- By all means, do not apply voltage to the "Flashing/Pulse Enable Common" line (Refer to "5.1. Wiring Examples" on page 14). Failure to comply may result in damage to the product.
- [A] AC 100 - 240V Type]
- Do not apply voltage, or connect the source line to the signal line. Failure to comply may result in damage to the product.

Please

- Be sure to check for proper wiring before connecting the power.
- To counter against noise, shorten all wiring as much as possible, and use shielded wire when possible. In addition, separate any signal lines which pass along high voltage cables or is susceptible to receive induction noises.
- If a non-voltage contact, such as a relay or switch etc., is used for the power supply line, consider inrush current capacity when selecting the contact. Contact welding and malfunction will occur if current capacity is insufficient.

Note

- Even when starting two or more units simultaneously, a lag will occur during flashing or the Alarm sound.

5.1. Wiring Examples

The wiring example indicates how to connect to external contacts for every classification.

If there are any special applications that require asking questions concerning this product, feel free to contact your PATLITE Sales Representative.

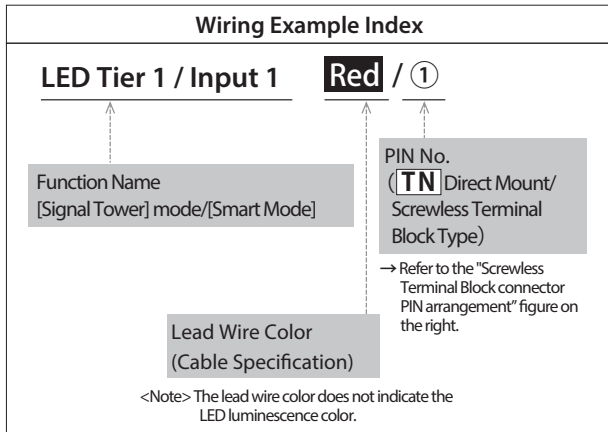

Alarm Sound Pattern (Factory Default)

Alarm 1	Alarm Sound No. 1
Alarm 2	Alarm Sound No. 2
Alarm 1 and Alarm 2 Entered Simultaneously	Alarm Sound No. 9

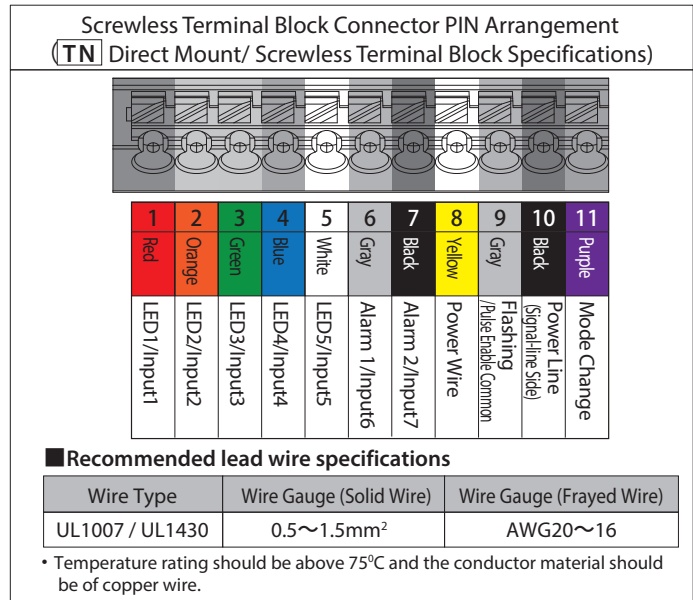

About the "Mode Change" switch-over

When entering the "Mode Change", the operating mode can be changed to the "Smart Mode." In the "Smart Mode", various lighting and alarm patterns can be arranged. Visit our company's homepage (<https://www.patlite.com>) for further details.

* For the "Mode Change" switch-over, refer to "6. Operating Directions" on page 19 for further details.

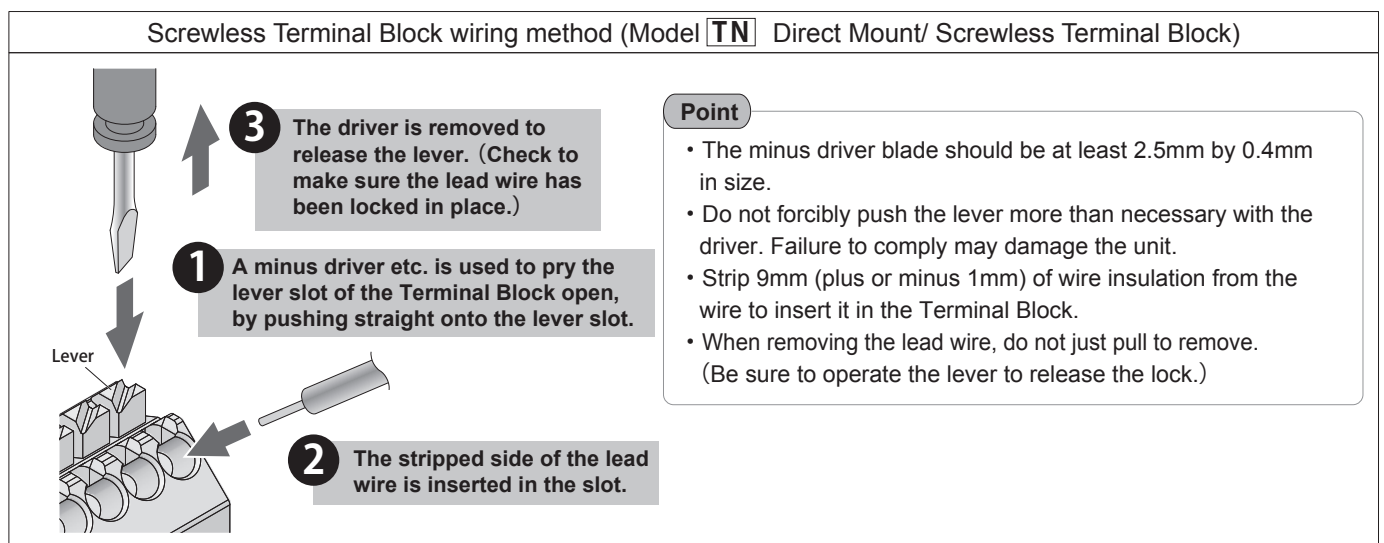

⚠ CAUTION

- When lighting and flashing are used together in the Signal Tower mode with a PLC, it is necessary to separate the flashing and non-flashing circuit outputs on the PLC side.

5.1.1. Connecting to Relay Contacts [DC24V Type]

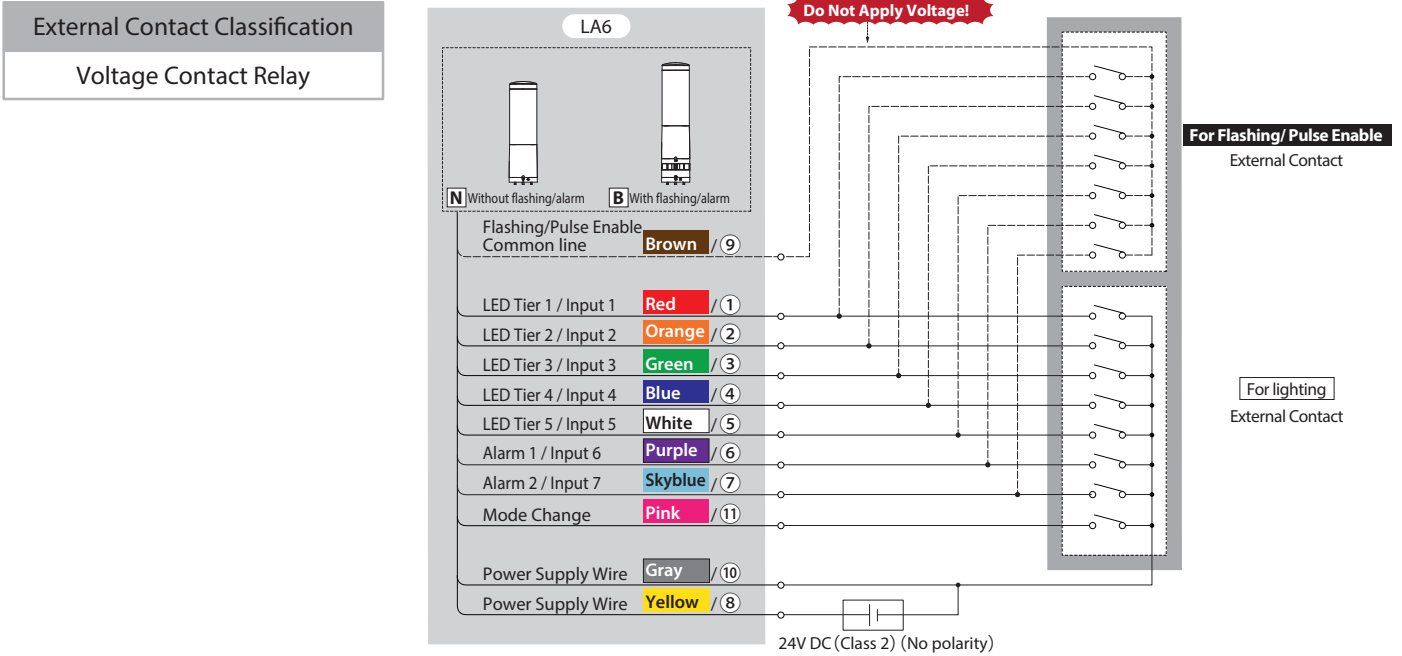

5.1.2. Connecting to a PLC (NPN) [DC 24V Type]

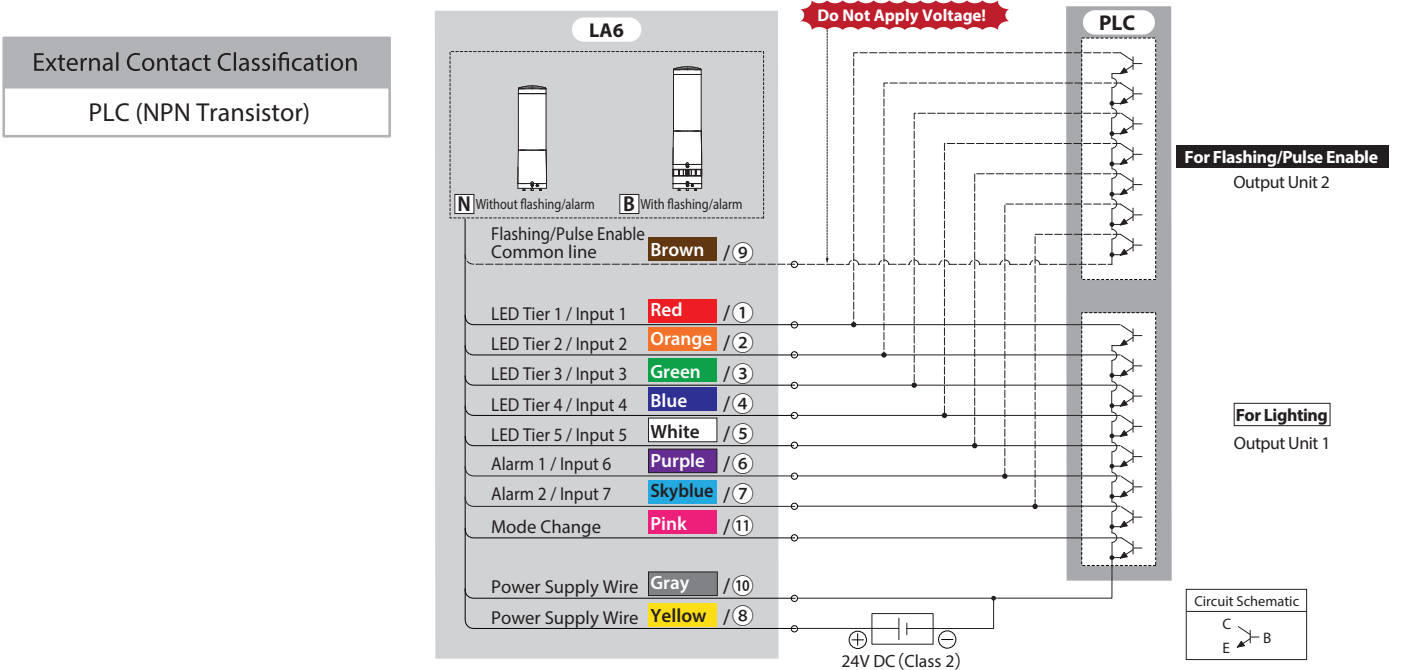

5.1.3. Connecting to a PLC (PNP) [DC 24V Type]

External Contact Classification
 PLC (PNP Transistor)

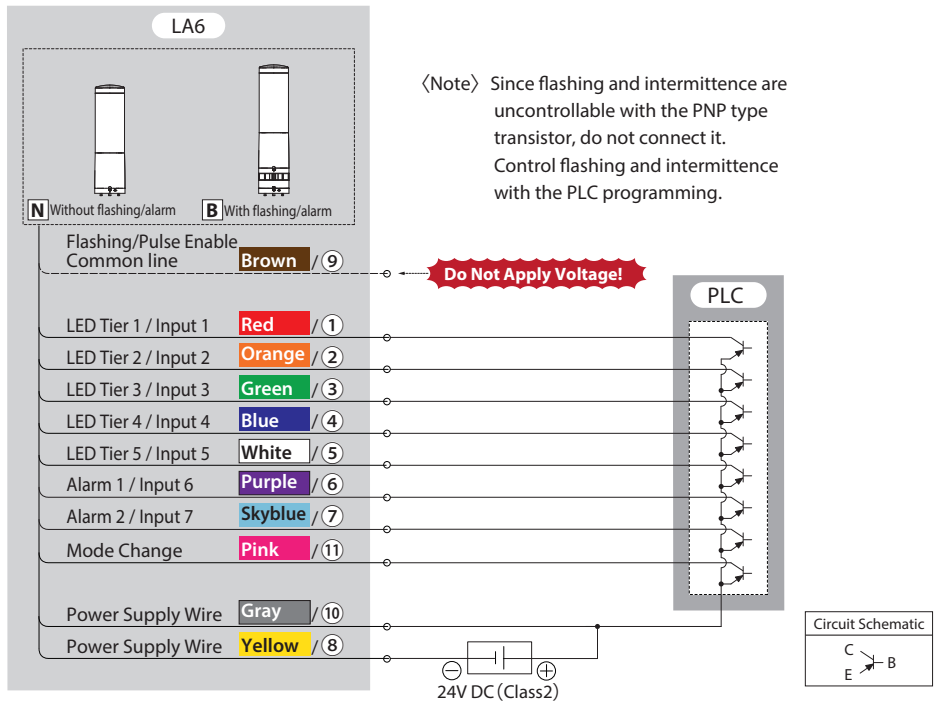

5.1.4. Connecting to Relay Contacts [AC 100 -240V Type]

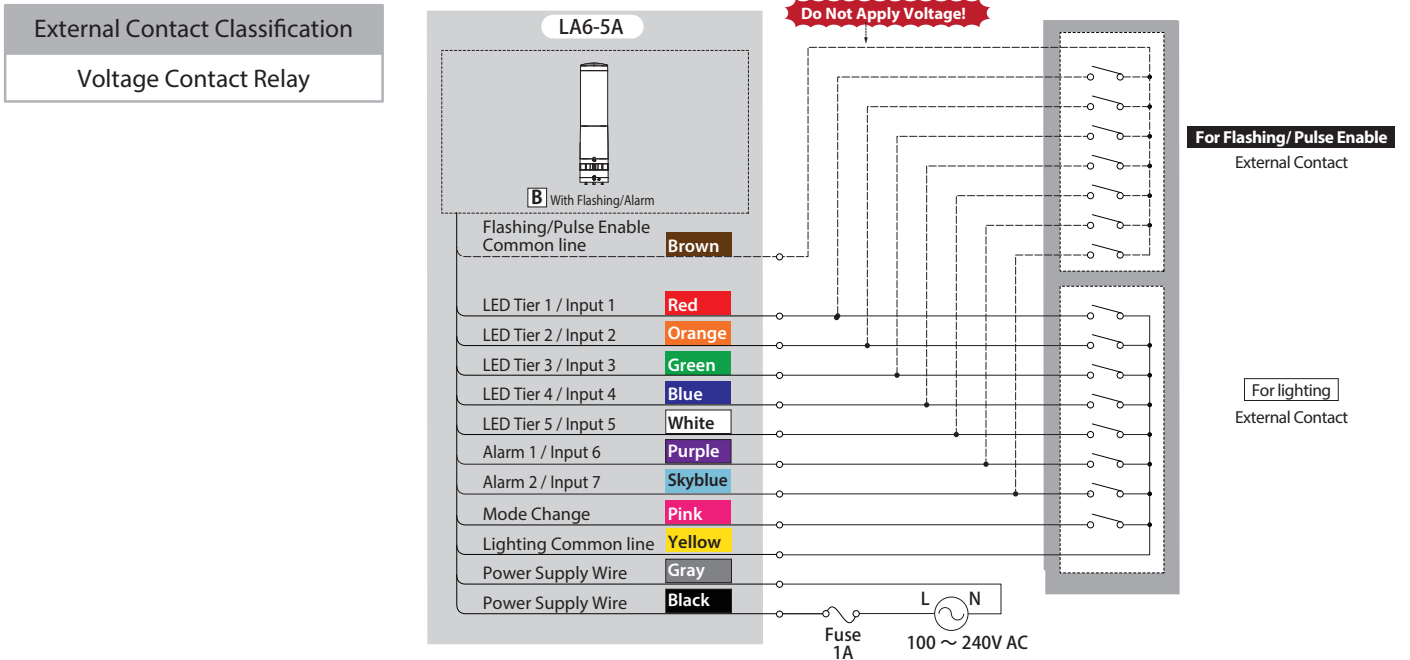

5.1.5. Connecting to a PLC (NPN) [AC 100 -240V Type]

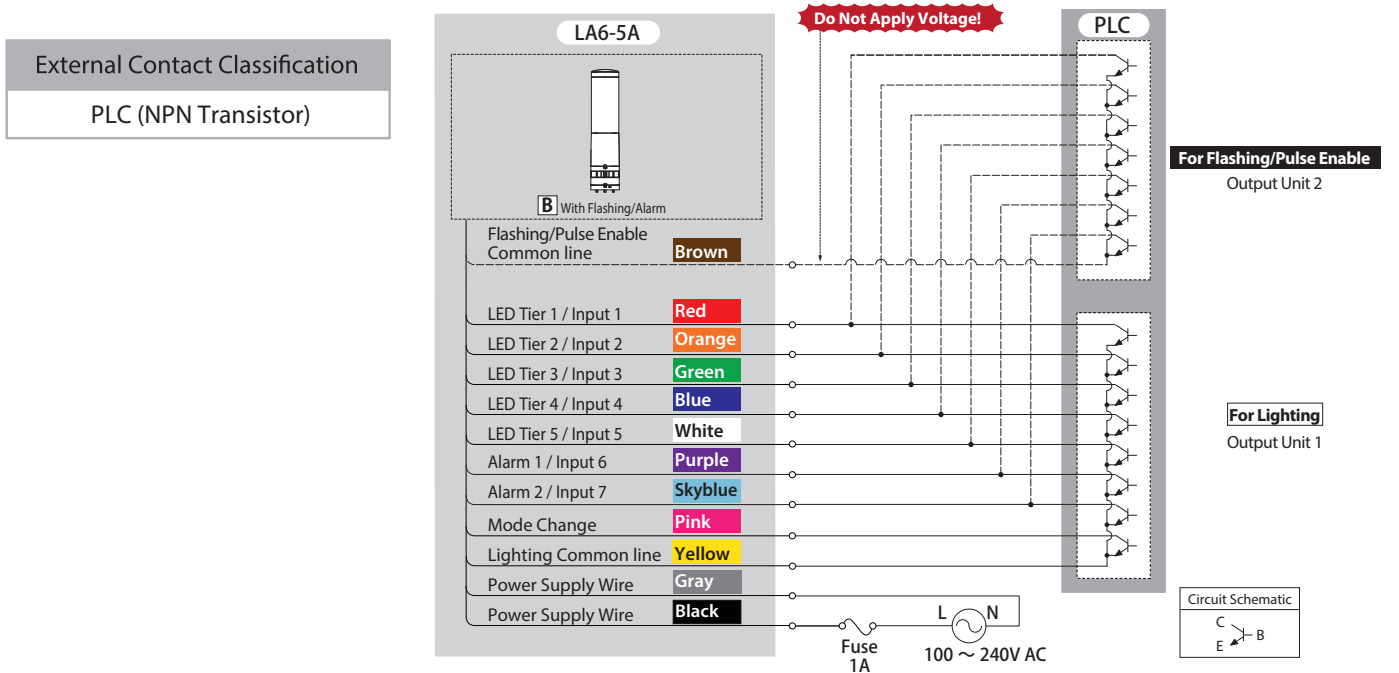

5.2. Current Capacity

5.2.1. Contact Capacity [DC 24V Type]

External Contact Classification

Voltage Contact Relay or PLC

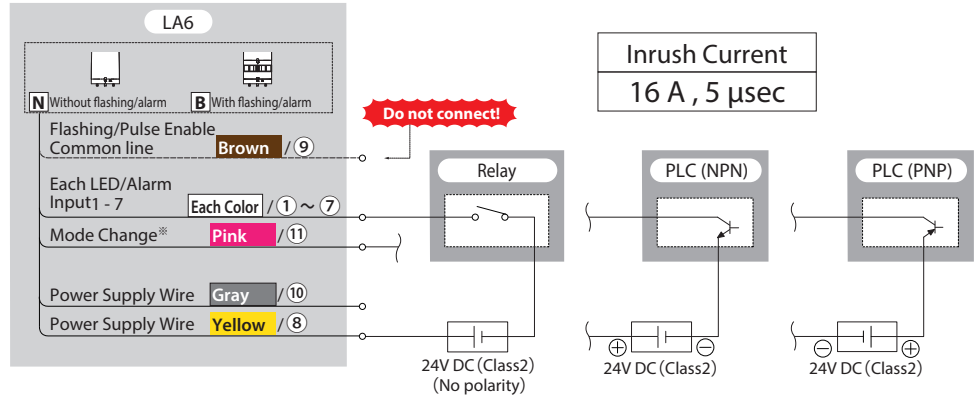

※ There is no inrush current on the Pink wire for "Mode Change."

Table 1 Signal Contact Capacity

Current Capacity	100mA or more
Withstand Voltage	DC 35V or more
Leakage Current	0.1mA or less
ON Voltage (Vsat)	1V or less

Table 2 Power Supply Inrush Current

Inrush Current Value	16A/5us
----------------------	---------

Table 3 Supply Current

Model	Current
LA6-3D □□□ N	170mA
LA6-3D □□□ B	210mA
LA6-5D □□□ N	260mA
LA6-5D □□□ B	300mA

5.2.2. Contact Capacity [AC 100 - 240V Type]

Table 1 Signal Contact Capacity

Current Capacity	100mA or more
Withstand Voltage	DC 35V or more
Leakage Current	0.1mA or less
ON Voltage (Vsat)	1V or less

Table 2 Power Supply Inrush Current

Inrush Current at 25°C	16A/2ms
Inrush Current at 50°C	50A/2ms

Table 3 Power Consumption

LA6-5AWJWB	7.5W
------------	------

Table 4z Fuse Ratings

250V/ 1A 5 x 20mm Fast-blow Glass Tube Fuse
--

Note

- When a regulated power supply is not being used, select a fuse that meets class CC or more.

6. Operating Directions

This product contains a multi-function button (Refer to “3.2. Part Names and Outer Appearance” on page 7) under the Head Cover in the upper section, which can be operated as follows:

- Alarm Sound Control: Adjustable up to four steps.
- LED Color Change: The luminescence color of each tier can be changed.
- Version Confirmation: The current version of the product can be checked.
- Product Initialization: The memory contents of the product can be cleared and returned to factory default values. (Returns to the “Signal Tower” mode. The alarm sound pattern and the “Smart Mode” setup conditions have not changed.)

The operation of this product contains two modes; “Signal Tower” mode and “Smart Mode.” The explanation for each mode shows fairly significant differences to them.

Changing between the “Signal Tower” mode and the “Smart Mode” is a simple ON/OFF input from the “Mode Change” signal input wire.

Signal input “Mode Change” ON: Smart Mode

Signal input “Mode Change” OFF: “Signal Tower” mode

Although a continuous hold input controls the inputs, only a trigger input in the pulse trigger mode for the “Smart Mode” turns into a one shot input. With the “Mode Change” in the OFF condition, the Multi-function button can be used for the recombination of colors, changing the amount of alarm sounds, and other product functionalities.

6.1. “Signal Tower” mode

The “Signal Tower” mode controls operation with ON/OFF inputs from the wires currently assigned to each LED and alarm, like our conventional Signal Towers. When short-circuiting each input to the “Flashing/Pulse Enable Common”, The LED will flash, and an intermittent alarm sound will occur.

The “Signal Tower” mode set up can be done in our “EDITOR for LA series” software application (Visit our homepage at <https://www.patlite.com/> to download the software.).

- Setup Parameters

This mode has parameters that can be set up as shown in the following table.

Setup Index	Description
LED lighting/flashing for flash per minute(fpm) rate	Flashing rates are selectable from 30fpm, 60fpm, or 120fpm.
Alarm Tone	Alarm sound muting or one tone can be selected from 11 varieties.
LED Color	LED lights can be selected for ON or OFF.

- LED Input Conversion Table

For inputs 1-7, LED and Alarm ON/OFF can be entered as indicated in the “Signal Tower” mode operation example.

Table 4. “Signal Tower” mode Input Conversion Table

1	LED Tier 1 (Red)	
2	LED Tier 2 (Amber)	
3	LED Tier 3 (Green)	
4	LED Tier 4 (Blue)	
5	LED Tier 5 (White)	
6	Alarm 1 Tone No.1	Alarm 3 Tone No.9
7	Alarm 2 Tone No.2	* When inputs are simultaneously entered

* Pre-set with Factory default

LA6 Signal Tower Complete Operation Manual

• “Signal Tower” mode operation example

Operating Condition	LED Tier 1	OFF	Blue	OFF	OFF	OFF	OFF	...	Red	Red	Red	Red Flashing	OFF
	LED Tier 2	OFF	Blue	Blue	OFF	OFF	OFF		Red	Red	Red	Red Flashing	OFF
	LED Tier 3	OFF	Blue	Blue	Blue	OFF	OFF		Red	Red	Red	Red Flashing	OFF
	LED Tier 4	OFF	Blue	Blue	Blue	Blue	OFF		OFF	Red	Red	Red Flashing	OFF
	LED Tier 5	OFF	Blue	Blue	Blue	Blue	Blue		OFF	Red	Red	Red Flashing	OFF
	Buzzer	Mute	Tone 1	Tone 2	Tone 7	Mute	Mute		Mute	Mute	Tone 11	Tone 13	Mute

Group/Pattern No.		1/1	1/2	1/3	1/4	1/5	...	1/60	1/61	1/62	1/63	
-------------------	--	-----	-----	-----	-----	-----	-----	------	------	------	------	--

Signal Input	Input 1	_____										
	Input 2	_____										
	Input 3	_____										
	Input 4	_____										
	Input 5 (STOP)	_____										
	Input 6 (Mute)	_____										
	Input 7 (Clear)	_____										

6.2. “Smart Mode”

There are three kind of modes, “Time-trigger” mode”, “Pulse-trigger” mode”, and “Single-display” mode”.

The factory default input is the “Time-trigger” mode, but there is a “Pulse-trigger” mode and “Single-display” mode, of which each type can be changed by the setup, which means it is necessary to create the setup data and transmit it to the product with a personal computer which has the “EDITOR for LA series” software application (Visit our homepage at <https://www.patlite.com/> to download the software.) installed in it. (Refer to “7. Changing Data” on page 37 for details on how to change the data) For details, please refer to the software help section.

The main mode has common functions for each type and has the following at this mode.

• Input 6 (“Mute” input)

The alarm sound stops when an “ON” input occurs, and muffles the sound.

• Input 7 (“Clear” input)

If an input for each type is set to ON, the pattern contents which are controlling the operation will be initialized and it will return to the first pattern. Also, LED’s from all the tiers will go out at an “ON” input, and the alarm is also muffled.

Refer to each mode for the explanation of how their “Clear” input should look.

6.2.1. “Time-trigger” mode

The “Time-trigger” mode has 63 set patterns to which the memory contains two or more patterns used as a series of wave-like flows, etc. that can be used in groups. The “Time-trigger” mode operates in accordance with time, and the pattern transition timing operates during this group operation. In addition, the maximum memory of 15 groups can be set up in ON/OFF combinations, and a call is made to inputs 1-4.

Moreover, the “Time-trigger” mode for input 5 turns into a “STOP” input, and during the input, operates by either one of the following conditions indicated below, and stops the time progress of the pattern changes.

- “STOP” input of a pattern currently on display to change to a lighted state.
- “STOP” input of a pattern currently on display to change to a flashing state.
- “STOP” input of a special pattern currently on display to change to a lighted state.
- “STOP” input of a special pattern currently on display to change to a flashing state.

The setup to select these can be performed in the “EDITOR for LA series” software application (Visit our homepage at <https://www.patlite.com/> to download the software.).



- Do not use the “Flashing/Pulse Enable” signal line when in the “Smart” mode..

• Setup Parameters

This mode has parameters that can be set up as shown in the following table.

Setup Range	Setting Index	Description
Every Group	Display Repeats	When even the last set-up pattern changes and display time is exceeded, it is either selected to return to the head pattern of the group, or is considered as the last pattern.
	Display Time Unit	Every 1 second and every 0.1 seconds are selected for the display time in units, to be set up for each pattern.
	STOP Input Operation	A STOP input can be selected for four operations when turned "ON."
Every Pattern	Display Time	Select the time until a pattern changes to the next pattern.
	LED Lighting/Flashing	Select all LEDs to turn on or flash. Flashing rates are selectable from 30 times per minute, 60 times per minute, or 120 times per minute.
	Alarm Tone	Alarm Silence or one tone can be selected from 11 varieties.
Every Tier	LED Color	LED lights On or Off can be selected.

• Group Input Conversion Table

For inputs 1-4, group No. in the combination of ON/OFF can be entered as indicated in the "Time-trigger" mode operation example.

Table 5. "Time-trigger" mode Input Conversion Table

Group No.	Input 1	Input 2	Input 3	Input 4
1	ON			
2		ON		
3	ON	ON		
4			ON	
5	ON		ON	
6		ON	ON	
7	ON	ON	ON	
8				ON
9	ON			ON
10		ON		ON
11	ON	ON		ON
12			ON	ON
13	ON		ON	ON
14		ON	ON	ON
15	ON	ON	ON	ON

An empty cell indicates the "OFF" condition.

Note

* In the "Time-trigger" mode, an "ON" state on input 5 (one shot pulse) can make a pattern change; an "ON" state on input 6 can cause the alarm to mute; and an "ON" state on input 7 can cause a "Clear" (reset of the operation).

LA6 Signal Tower Complete Operation Manual

- **“Time-trigger” mode Operation Example**

The following are examples of the “Time-trigger” mode operation. In addition to time progress and pattern changes, the figure also shows the “Mute” input operation.

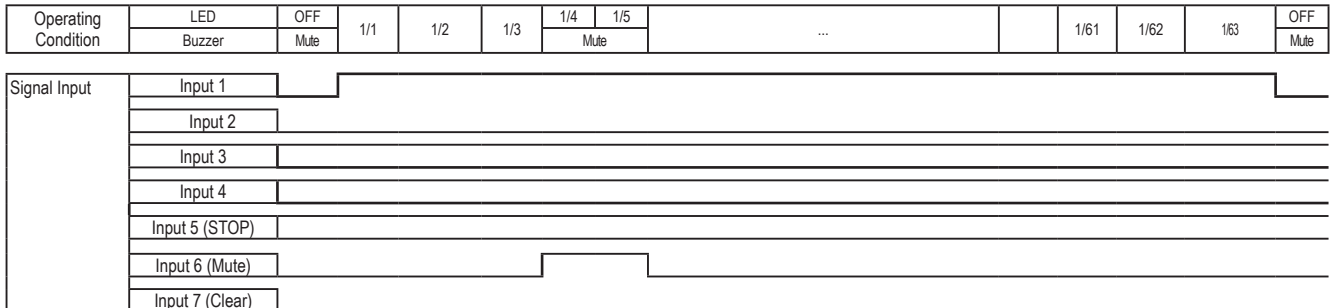

* The “Time-trigger” mode operating state is an example for setting data.

In addition to time progress and pattern changes, the figure also shows the STOP input operation, the mute input, and the clear input. A “STOP” input setup shows an indication of the pattern at a “STOP” input by flashing.

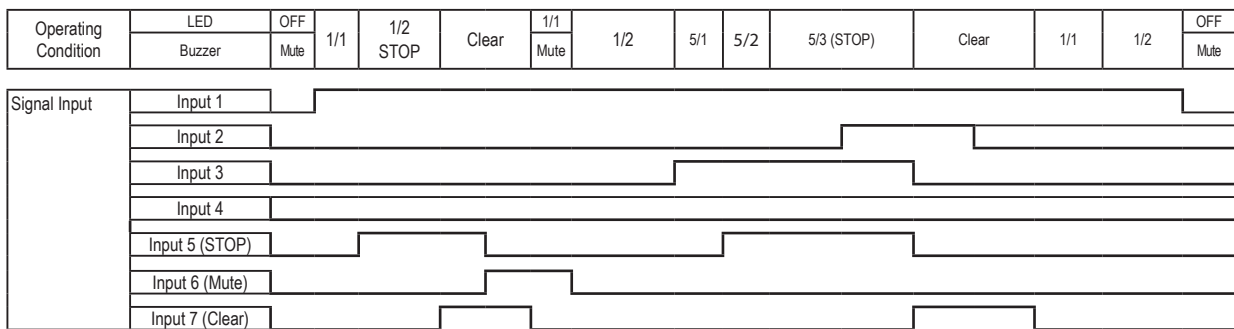

* The “Time-trigger” mode operating state is an example for setting data.

6.2.2. “Pulse-trigger” mode

The “Pulse-trigger” mode is operated like the “Time-trigger” mode for a group. However, with the pattern transition timing, it is only used as a one shot pulse for input 5.

The memory for a maximum of 15 groups can be used, and the combination of ON/OFF to inputs 1-4 performs a call. This setup can be made in the “EDITOR for LA series” software application (Visit our homepage at <https://www.patlite.com/> to download the software application and other features for the LA6.).

- **Setup Parameters**

This mode has parameters that can be set up as shown in the following table.

Setup Range	Setting Index	Description
Every Pattern	LED Lighting/Flashing	Select all LEDs to turn on or flash. Flashing rates are selectable from 30 times per minute, 60 times per minute, or 120 times per minute.
	Alarm Tone	Alarm Silence or one tone can be selected from 11 varieties.
Every Tier	LED Color	LED lights On or Off can be selected.

• Group Input Conversion Table

For inputs 1-4, group No. in the combination of ON/OFF can be entered as indicated in the "Pulse-trigger" mode operation example.

Table 6. "Pulse-trigger" mode Input Conversion Table

Group No.	Input 1	Input 2	Input 3	Input 4
1	ON			
2		ON		
3	ON	ON		
4			ON	
5	ON		ON	
6		ON	ON	
7	ON	ON	ON	
8				ON
9	ON			ON
10		ON		ON
11	ON	ON		ON
12			ON	ON
13	ON		ON	ON
14		ON	ON	ON
15	ON	ON	ON	ON

An empty cell indicates the "OFF" condition.

Note

* With a "Pulse-trigger" mode, an "ON" state on input 5 (one shot pulse) can make a pattern change; an "ON" state on input 6 can cause the alarm to mute; and an "ON" state on input 7 can cause a "Clear" (reset of the operation).

• "Pulse-trigger" mode Operation Example

The following are examples of the "Pulse-trigger" mode operation.

In addition to trigger input and pattern changes, the figure shows the operation of the "Mute" input.

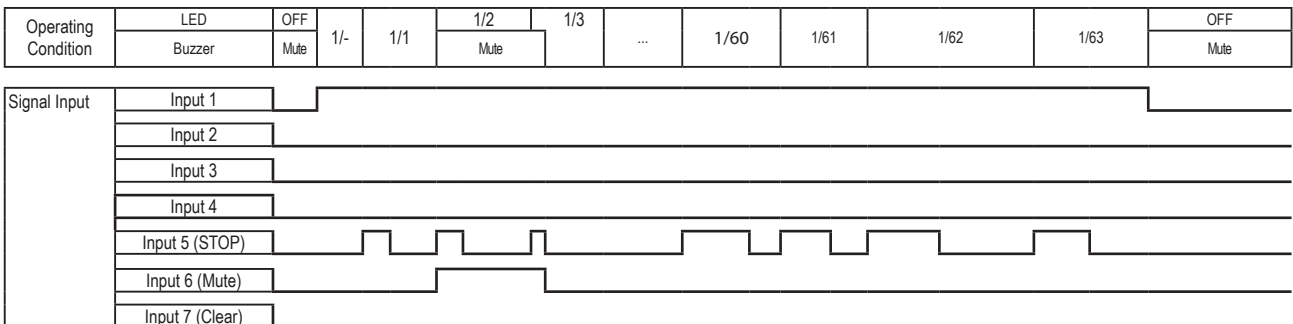

* The "Pulse-trigger" mode operating state is an example for setting data.

LA6 Signal Tower Complete Operation Manual

In addition to trigger input and pattern changes, the figure shows the operation of the “Mute” input and the “Clear” input.

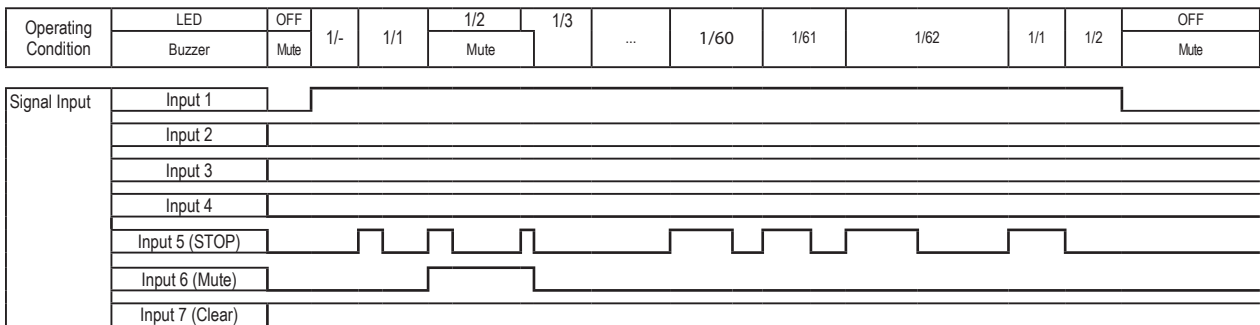

Note

The one shot trigger input pulse acquires only the rise-time of the input. Refer to “8.1. Basic Signal Input Time Chart” on page 38 for more details.

6.2.3. “Single-display” mode

There are 31 group varieties with the product’s internal memory that can be used in combination of ON/OFF inputs from signal wire inputs 1-5 to operate the LED display colors. Although the Flashing/Alarm functions can be used, the LED wave-like color flow, etc., cannot be used.

The setup for each group can be made in the “EDITOR for LA series” software application (Visit our homepage at <https://www.patlite.com/> to download the software application and other features for the LA6.).

- Setup Parameters

This mode has parameters that can be set up as shown in the following table.

Setup Range	Setting Index	Description
Every Group	LED Lighting/Flashing	Select all LEDs to turn on or flash. Flashing rates are selectable from 30 times per minute, 60 times per minute, or 120 times per minute.
	Alarm Tone	Alarm Silence or one tone can be selected from 11 varieties.
Every Tier	LED Color	LED lights On or Off can be selected.

LA6 Signal Tower Complete Operation Manual

• Group Input Conversion Table

For inputs 1-5, Group numbers in combination of ON/OFF can be entered as indicated in the “Single-display” mode operation example.

Table 7. “Single-display” mode Input Conversion Table

Group No.	Input 1	Input 2	Input 3	Input 4	Input 5	Group No.	Input 1	Input 2	Input 3	Input 4	Input 5
1	ON					17	ON				ON
2		ON				18		ON			ON
3	ON	ON				19	ON	ON			ON
4			ON			20			ON		ON
5	ON		ON			21	ON		ON		ON
6		ON	ON			22		ON	ON		ON
7	ON	ON	ON			23	ON	ON	ON		ON
8				ON		24				ON	ON
9	ON			ON		25	ON			ON	ON
10		ON		ON		26		ON		ON	ON
11	ON	ON		ON		27	ON	ON		ON	ON
12			ON	ON		28			ON	ON	ON
13	ON		ON	ON		29	ON		ON	ON	ON
14		ON	ON	ON		30		ON	ON	ON	ON
15	ON	ON	ON	ON		31	ON	ON	ON	ON	ON
16					ON	An empty cell indicates the “OFF” condition.					

Note

* For the “Single-display” mode, with an “ON” status on input 6, a “Clear” (reset of the operation) can be executed, and an “ON” status on input 7 can cause the alarm to be muted.

• “Single-display” mode Operation Example

The following are examples of the “Single-display” mode operation.

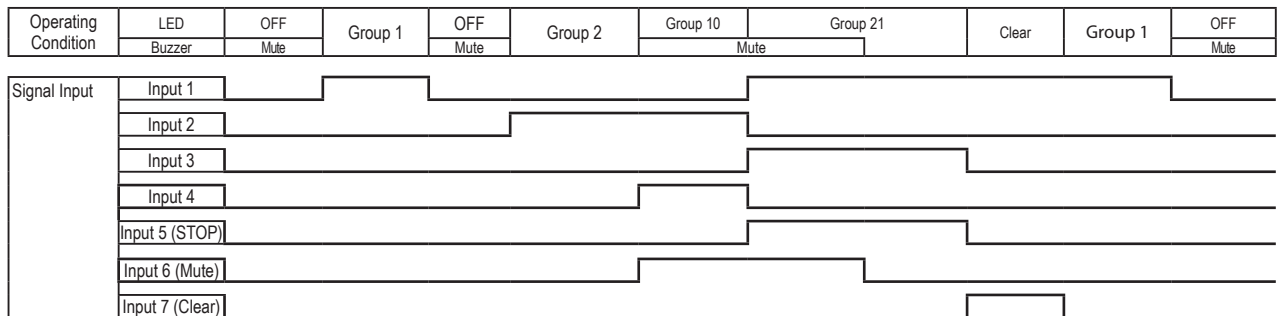

6.3. Multi-function Button Operation

This product contains a multi-function button ("3. Part Names and Dimensions" on page 6) under the Head Cover in the upper section, which can be operated as follows:

- Alarm Sound Control : Four adjustable steps.
- LED Color Change : The luminescence color of each tier can be changed.
- Version Confirmation : The current version of the product can be checked.
- Product Initialization : The memory contents of the product can be cleared and returned to factory default values.

(Returns to the "Signal Tower" mode. The alarm sound pattern and the "Smart Mode" setup data have not changed.)

The following figure shows the timing when pushing the Multi-function Button to perform these operations.

As a caution, no signal inputs are received during each setup.

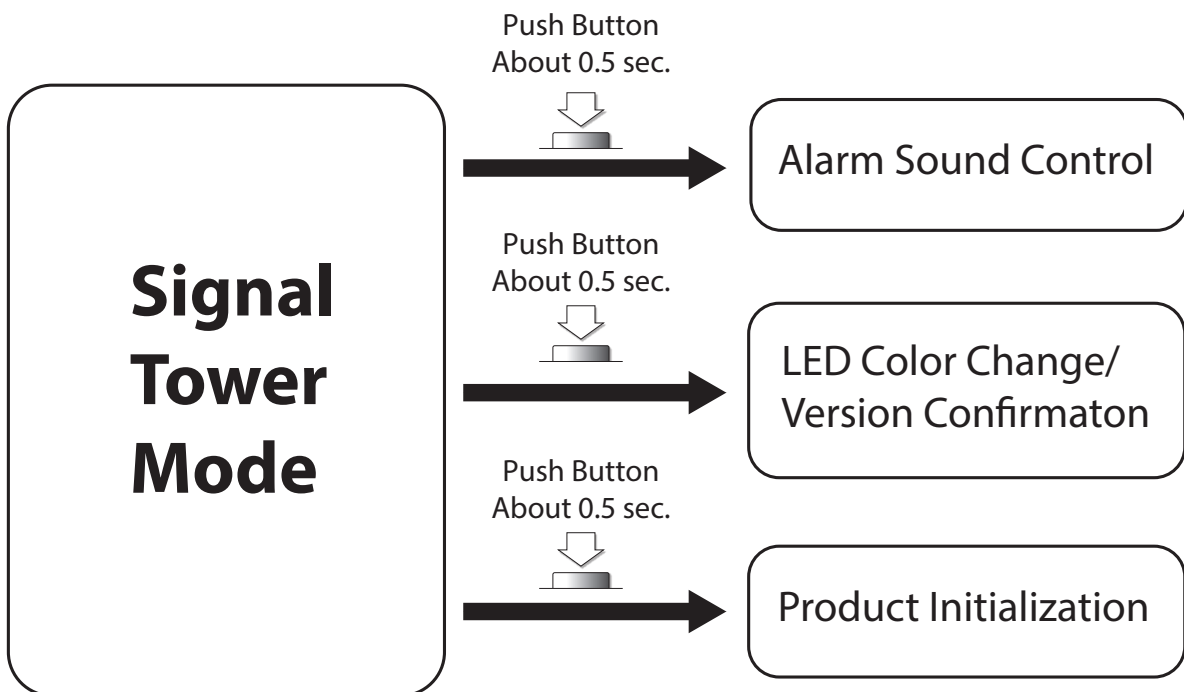

6.3.1. Alarm Sound Control

The "Alarm Sound Control" is adjustable by pushing the Multi-function Button for about 0.5 seconds. Whenever the Multi-function Button is pushed, the volume changes in the order according to the following figure below, and a beep sound is heard with the changing of the volume. Volume adjustment is completed when the beep sound is heard.

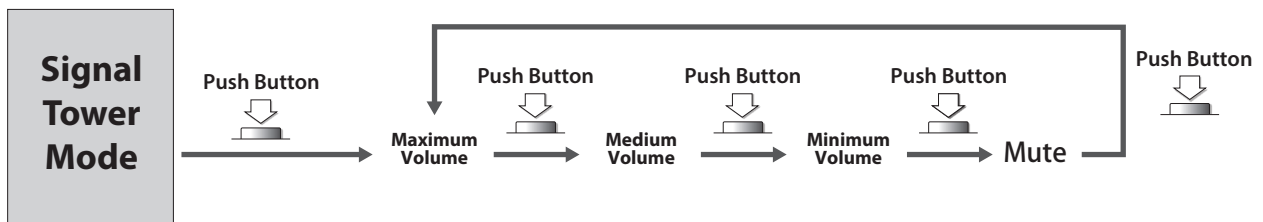

6.3.2. LED Color Change/Version Confirmation

When all LED tiers flash a green color, the “LED Color Change/Version Confirmation” can be selected while it is in that status. As shown in the following figure, when the Multiple-function Button is pushed for about 0.5 seconds, 3 different selections: the “LED Color Change”; “Version Confirmation”; and returning to “Signal Tower” mode, can be selected. Once the selection is made, if the Multiple-function button is pushed about 3 seconds longer, then the mode goes into the status selected.

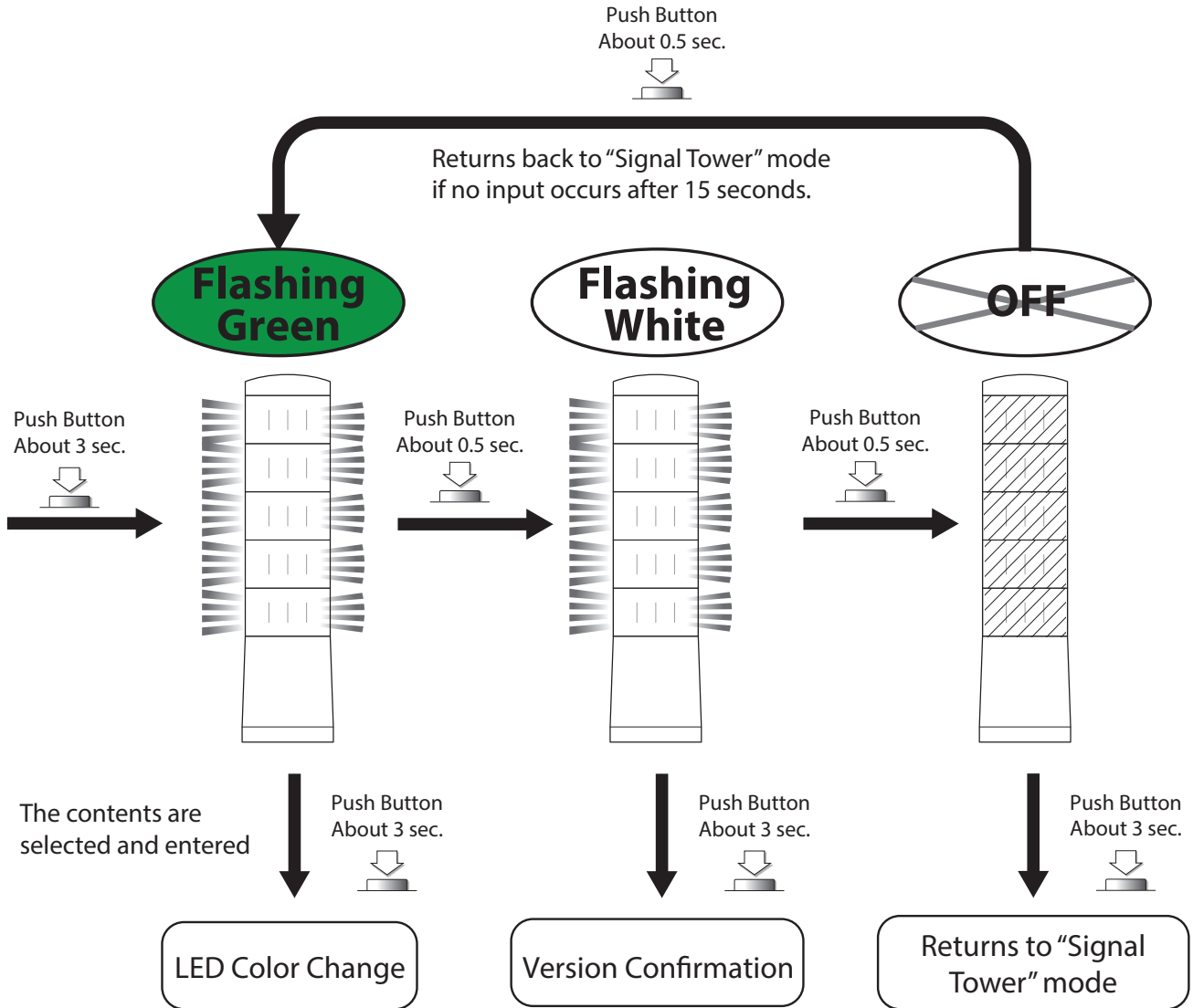

6.3.2.1. LED Color Change

The LED color which operates in the “Signal Tower” mode can be changed. First, the LED color change starts from the 1st tier where the red LED turns on. As shown in the following figure, whenever the Multiple-function button is pressed for a short time (about 0.5 second), the 1st LED Tier color changes in order.

LA6 Signal Tower Complete Operation Manual

To change the LED color to a different preference, by pushing the Multiple-function for about 3 seconds, the expected color status that is on (such as the 1st LED tier color) can change to the next LED tier color (such as the 2nd LED tier color) by selecting the desired lighted state. Once the last LED tier color is changed and the Multiple-function Button is pushed about another 3 seconds, all LED color changes are complete.

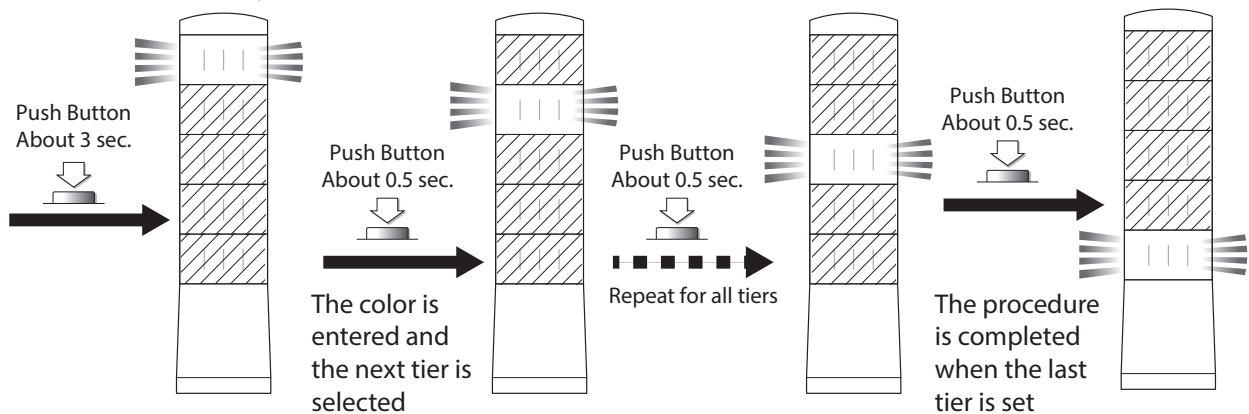
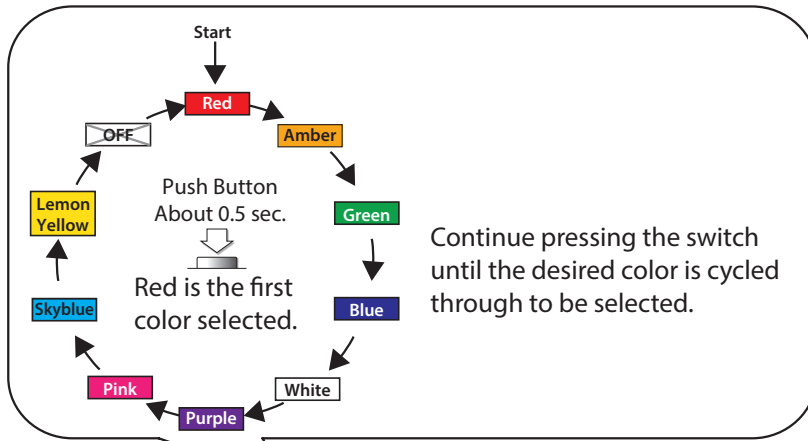

6.3.2.2. Version Confirmation

To verify the firmware version, three LED tiers will flash in accordance to the current firmware version, indicated from top to bottom. The following table indicates the meaning for each flashing LED color and the corresponding number.

LED Color	Corresponding Number
OFF	0
RED	1
AMBER	2
GREEN	3
BLUE	4
WHITE	5
PURPLE	6
PINK	7
SKY-BLUE	8
LEMON	9

The version is expressed in the order from the LED top to bottom, as shown in the figure below.

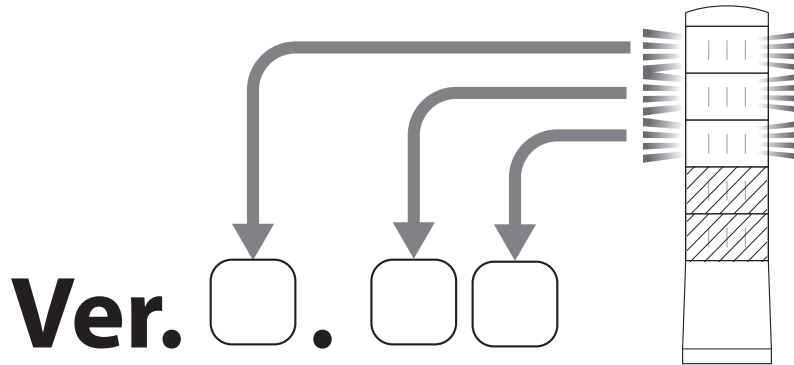

For a detailed verification of the current version, the "EDITOR for LA series" software application can be used to check from the PC.

If there is no personal computer, etc., available in its environment, contact your nearest Patlite Sales Representative and tell them the status of LED tiers displayed to determine the current firmware version.

To exit from the "Version Confirmation" status, pressing the Multiple-function Button for about 3 seconds, or leaving it for 15 seconds untouched, will automatically cause it to return to its normal operation.

6.3.2.3. Product Initialization

The flashing speed of the white LED gradually becomes faster while holding the Multiple-function Button down until the White LED is in its full flashing state. The first flashing lasts about 15 seconds before the flash rate increases, and by continuing to push the Multiple-function Button, the White LED goes out after 10 seconds and Initialization (product returns to "Signal Tower" mode and values are back to factory default) is completed.

Continue pushing button until initialization is complete.

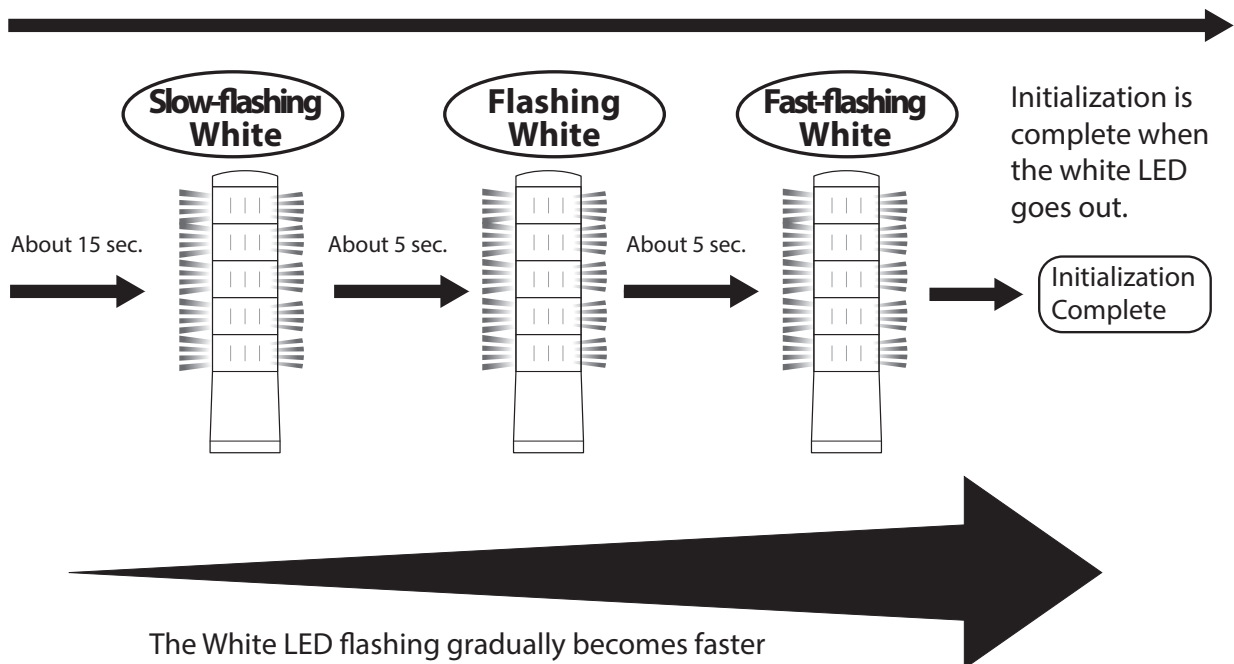

Note

- If the "Multiple-function" Button is released before initialization is completed, it returns to the "Signal Tower" mode.
- After pushing the "Multiple-function" Button, the standard time to completely return to factory default is 30 seconds.
- Initialization is only possible in the "Signal Tower" mode.

6.4. Factory Default Data

6.4.1. "Signal Tower" mode

The following chart indicates the default set up values.

Setup Index	Setup Contents
LED Tier 1 Color	Red
LED Tier 2 Color	Amber
LED Tier 3 Color	Green
LED Tier 4 Color	Blue (No setup if it is a 3 tier model)
LED Tier 5 Color	White (No setup if it is a 3 tier model)
Alarm 3 Tone	Tone No. 3
Flashing Cycle	60 fpm

6.4.2. "Smart Mode"

The following chart indicates the default set up when entering the "Smart Mode."

Setup Index	Setup Contents
Input Type	Time Trigger Type

The following tables indicate various groups in which the contents their groups contain various operations.

• Table for Various Operations

The details of the 5 tier group setup is shown in the following table. As a note, a conversion table at the end of the group table indicates the LED color indicated according to the color number in the group tables.

Group No.	STOP Operation	Repeat Setup	Pattern No.	LED Color (Tier)					Flashing Setup	Alarm Sound	Lighting Duration (Seconds)
				1st	2nd	3rd	4th	5th			
1	The pattern is displayed when an input occurs.	YES	1	1	1	1	1	1	ON	0	1
2	The pattern is displayed when an input occurs.	YES	1	5	5	5	5	5	ON	0	1
3	The pattern is displayed when an input occurs.	YES	1	9	9	9	9	9	ON	0	1
4	The pattern is displayed when an input occurs.	YES	1	13	13	13	13	13	ON	0	1
5	The pattern is displayed when an input occurs.	YES	1	21	21	21	21	21	ON	0	1
5			STOP	13	13	13	13	5	ON	1	
6	The pattern is displayed when an input occurs.	YES	1	16	16	16	16	16	ON	0	1
7	The pattern is displayed when an input occurs.	YES	1	17	17	17	17	17	ON	0	1
8	The pattern is displayed when an input occurs.	YES	1	11	11	11	11	11	ON	0	1
9	The pattern is displayed when an input occurs.	YES	1	7	7	7	7	7	ON	0	1
10	The pattern is displayed when an input occurs.	YES	1	16	17	11	7	21	ON	0	1

Continue to the next page...

LA6 Signal Tower Complete Operation Manual

Group No.	STOP Operation	Repeat Setup	Pattern No.	LED Color (Tier)					Flashing Setup	Alarm Sound	Lighting Duration (Seconds)
				1st	2nd	3rd	4th	5th			
11	The pattern is displayed when an input occurs.	YES	1	22	22	22	22	22	ON	0	1
			2	1	1	1	1	1	ON	0	1
			3	5	5	5	5	5	ON	0	1
			4	9	9	9	9	9	ON	0	1
			5	13	13	13	13	13	ON	0	1
			6	21	21	21	21	21	ON	0	1
			7	16	16	16	16	16	ON	0	1
			8	17	17	17	17	17	ON	0	1
			9	7	7	7	7	7	ON	0	1
			10	8	8	8	8	8	ON	0	1
			11	11	11	11	11	11	ON	0	1
			12	1	1	1	1	1	ON	0	1
			13	22	22	22	22	22	ON	0	1
			14	21	13	9	5	1	ON	0	1
			15	1	2	3	4	5	ON	0	1
			16	5	6	7	8	9	ON	0	1
			17	9	10	11	12	13	ON	0	1
			18	13	14	15	16	17	ON	0	1
			19	17	18	19	20	21	ON	0	1
12	The pattern is displayed when an input occurs.	NO	1	22	22	22	22	22	ON	0	1
			2	22	22	22	22	13	ON	0	1
			3	22	22	22	13	13	ON	0	1
			4	22	22	13	13	13	ON	0	1
			5	22	13	13	13	13	ON	0	1
			6	13	13	13	13	13	ON	0	1
			7	22	22	22	22	22	ON	0	1
			8	22	16	16	16	16	ON	0	1
			9	22	22	16	16	16	ON	0	1
			10	22	22	22	16	16	ON	0	1
			11	22	22	22	22	16	ON	0	1
			12	22	22	22	22	22	ON	0	1
			13	22	22	22	22	9	ON	0	1
			14	22	22	22	9	9	ON	0	1
			15	22	22	9	9	9	ON	0	1
			16	22	9	9	9	9	ON	0	1
			17	9	9	9	9	9	ON	0	1
			18	9	9	9	9	9	120fpm	0	1
			19	1	1	1	1	1	ON	0	1
			20	22	1	1	1	1	ON	0	1
			21	22	22	1	1	1	ON	0	1
			22	22	22	22	1	1	ON	0	1
			23	22	22	22	22	1	ON	0	1
			24	22	22	22	22	1	120fpm	0	1

Continue to the next page...

LA6 Signal Tower Complete Operation Manual

Group No.	STOP Operation	Repeat Setup	Pattern No.	LED Color (Tier)					Flashing Setup	Alarm Sound	Lighting Duration (Seconds)
				1st	2nd	3rd	4th	5th			
13	The pattern is displayed when an input occurs.	YES	1	22	22	22	22	1	ON	0	0.5
			2	22	22	22	1	22	ON	0	0.5
			3	22	22	1	22	22	ON	0	0.5
			4	22	1	22	22	22	ON	0	0.5
			5	1	22	22	22	22	ON	0	0.5
			6	22	22	22	22	1	ON	0	0.5
			7	22	22	22	1	22	ON	0	0.5
			8	22	22	1	22	22	ON	0	0.5
			9	22	1	22	22	22	ON	0	0.5
			10	1	22	22	22	22	ON	0	0.5
			11	22	22	22	22	22	ON	0	0.5
			12	13	22	22	22	22	ON	0	0.5
			13	22	13	22	22	22	ON	0	0.5
			14	22	22	13	22	22	ON	0	0.5
			15	22	22	22	13	22	ON	0	0.5
			16	22	22	22	22	13	ON	0	0.5
			17	13	22	22	22	22	ON	0	0.5
			18	22	13	22	22	22	ON	0	0.5
			19	22	22	13	22	22	ON	0	0.5
			20	22	22	22	13	22	ON	0	1
			21	22	22	22	22	13	ON	0	1
14	The pattern is displayed when an input occurs.	YES	1	9	9	9	9	9	ON	0	1
			2	22	9	9	9	9	ON	0	1
			3	22	22	9	9	9	ON	0	1
			4	22	22	22	9	9	ON	0	1
			5	22	22	22	22	9	ON	0	1
			6	5	5	5	5	5	ON	0	1
			7	22	5	5	5	5	ON	0	1
			8	22	22	5	5	5	ON	0	1
			9	22	22	22	1	1	ON	0	1
			10	22	22	22	22	1	ON	0	1
			11	1	1	1	1	1	120fpm	0	1
15	The pattern is displayed when an input occurs.	YES	1	22	22	22	22	22	ON	0	2
			2	9	9	9	22	22	ON	0	1.5
			3	5	5	9	9	9	ON	0	1.5
			4	9	22	9	22	9	ON	0	1.5
			5	1	22	22	22	22	ON	0	1.5
			6	1	22	1	22	22	ON	0	1.5
			7	1	22	1	22	1	ON	0	1.5
			8	1	22	22	22	22	ON	0	1.5
			9	1	22	1	22	22	ON	0	1.5
			10	1	22	1	22	1	ON	0	1.5
			11	5	9	9	5	22	ON	0	1.5
			12	9	9	9	22	22	ON	0	1.5

Continue to the next page...

LA6 Signal Tower Complete Operation Manual

The details of the three-tier group setup is shown in the following tables.

Group No.	STOP Operation	Repeat Setup	Pattern No.	LED Color (Tier)			Flashing Setup	Alarm Sound	Lighting Duration (Seconds)
				1st	2nd	3rd			
1	The pattern is displayed when an input occurs.	YES	1	1	1	1	ON	0	1
2	The pattern is displayed when an input occurs.	YES	1	5	5	5	ON	0	1
3	The pattern is displayed when an input occurs.	YES	1	9	9	9	ON	0	1
4	The pattern is displayed when an input occurs.	YES	1	13	13	13	ON	0	1
5	The pattern is displayed when an input occurs.	YES	1	21	21	21	ON	0	1
6	The pattern is displayed when an input occurs.	YES	1	16	16	16	ON	0	1
7	The pattern is displayed when an input occurs.	YES	1	17	17	17	ON	0	1
8	The pattern is displayed when an input occurs.	YES	1	11	11	11	ON	0	1
9	The pattern is displayed when an input occurs.	YES	1	7	7	7	ON	0	1
10	The pattern is displayed when an input occurs.	YES	1	17	11	7	ON	0	1

Continue to the next page...

LA6 Signal Tower Complete Operation Manual

Group No.	STOP Operation	Repeat Setup	Pattern No.	LED Color (Tier)			Flashing Setup	Alarm Sound	Lighting Duration (Seconds)
				1st	2nd	3rd			
11	The pattern is displayed when an input occurs.	YES	1	22	22	22	ON	0	1
			2	1	1	1	ON	0	1
			3	5	5	5	ON	0	1
			4	9	9	9	ON	0	1
			5	13	13	13	ON	0	1
			6	21	21	21	ON	0	1
			7	16	16	16	ON	0	1
			8	17	17	17	ON	0	1
			9	7	7	7	ON	0	1
			10	8	8	8	ON	0	1
			11	11	11	11	ON	0	1
			12	1	1	1	60fpm	0	1
			13	22	22	22	ON	0	1
			14	9	5	1	ON	0	1
			15	1	2	3	ON	0	1
			16	4	5	6	ON	0	1
			17	7	8	9	ON	0	1
			18	10	11	12	ON	0	1
			19	13	14	15	ON	0	1
			20	16	17	18	ON	0	1
			21	19	20	21	ON	0	1
12	The pattern is displayed when an input occurs.	NO	1	22	22	22	ON	0	1
			2	22	22	13	ON	0	1
			3	22	13	13	ON	0	1
			4	13	13	13	ON	0	1
			5	22	22	22	ON	0	1
			6	22	16	16	ON	0	1
			7	22	22	16	ON	0	1
			8	22	22	22	ON	0	1
			9	22	22	9	ON	0	1
			10	22	9	9	ON	0	1
			11	9	9	9	ON	0	1
			12	9	9	9	120fpm	0	1
			13	1	1	1	ON	0	1
			14	22	1	1	ON	0	1
			15	22	22	1	ON	0	1
			16	22	22	1	120fpm	0	1

Continue to the next page...











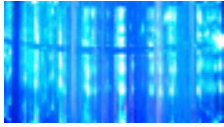
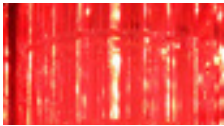
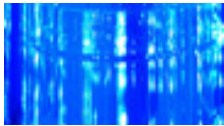
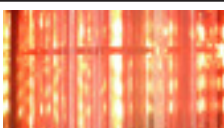
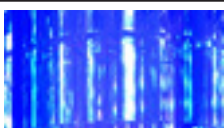

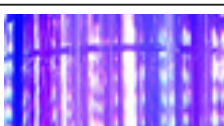
LA6 Signal Tower Complete Operation Manual

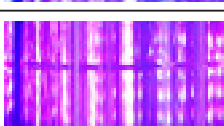
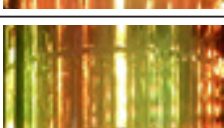
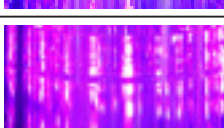
Group No.	STOP Operation	Repeat Setup	Pattern No.	LED Color (Tier)			Flashing Setup	Alarm Sound	Lighting Duration (Seconds)
				1st	2nd	3rd			
13	The pattern is displayed when an input occurs.	YES	1	22	22	1	On	0	0.5
			2	22	1	22	On	0	0.5
			3	1	22	22	On	0	0.5
			4	22	22	1	On	0	0.5
			5	22	1	22	On	0	0.5
			6	1	22	22	On	0	0.5
			7	22	22	22	On	0	0.5
			8	13	22	22	On	0	0.5
			9	22	13	22	On	0	0.5
			10	22	22	13	On	0	0.5
			11	13	22	22	On	0	0.5
			12	22	13	22	On	0	0.5
			13	22	22	13	On	0	0.5
14	The pattern is displayed when an input occurs.	YES	1	9	9	9	On	0	1
			2	22	9	9	On	0	1
			3	22	22	9	On	0	1
			4	9	9	22	On	0	1
			5	5	5	5	On	0	1
			6	22	5	5	On	0	1
			7	22	22	1	On	0	1
			8	1	1	1	120 fpm	0	1
15	The pattern is displayed when an input occurs.	YES	1	22	22	22	On	0	2
			2	9	9	9	On	0	1.5
			3	5	5	9	On	0	1.5
			4	9	22	9	On	0	1.5
			5	1	22	22	On	0	1.5
			6	1	22	1	On	0	1.5
			7	1	22	22	On	0	1.5
			8	1	22	1	On	0	1.5
			9	5	9	5	On	0	1.5
			10	9	9	22	On	0	1.5

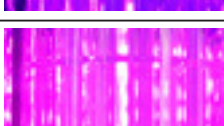
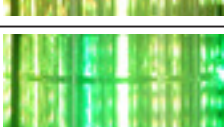
• Color Number Conversion Table

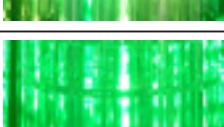
The following table indicates the kind of color in reference to the color number in the charts below.

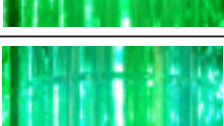
The color image may vary from actual color due to the computer screen or the printing quality of this manual.

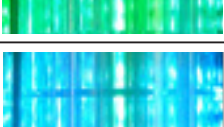
Color Number	Color Image	Color Number	Color Image
1 (Red)		12	
2		13 (Blue)	
3		14	
4		15	
5 (Amber)		16 (Purple)	
6		17 (Peach)	
7 (Lemon)		18	
8		19	
9 (Green)		20	
10		21 (White)	
11		22 (Off)	-

7. Changing Data

With the "EDITOR for LA series" application software, setup data can be changed and transmitted into this product.

• Necessary Items

- This product
- Personal Computer (with all hardware operating normally)
- Micro-USB Cable for Charging/Data Transfer (* USB-A male to USB Micro-B male is not included with this product.)
- "EDITOR for LA series" Application Software (Visit our homepage at <https://www.patlite.com/> to download it.)
Supporting OS: Windows® 7 32 bit/64 bit, and Windows® 8 32 bit/64 bit, Windows® 8.1 32 bit/64 bit and Windows® 10 32 bit/64 bit

• Transfer Procedure

- A. Product changes to standby status in which all signal inputs are "OFF" (Power supply input can be ON or OFF, whichever is easier)
- B. Open the USB Cover to the product, use the Micro-USB Cable to connect the product to the personal computer.
- C. Click the "Transmission" button in the "EDITOR for LA series" application software.
- D. From the start of data transfer, it takes about 15 seconds before the "Transfer was completed" prompt is displayed.
- E. Remove the Micro-USB cable and close the USB Cover completely.

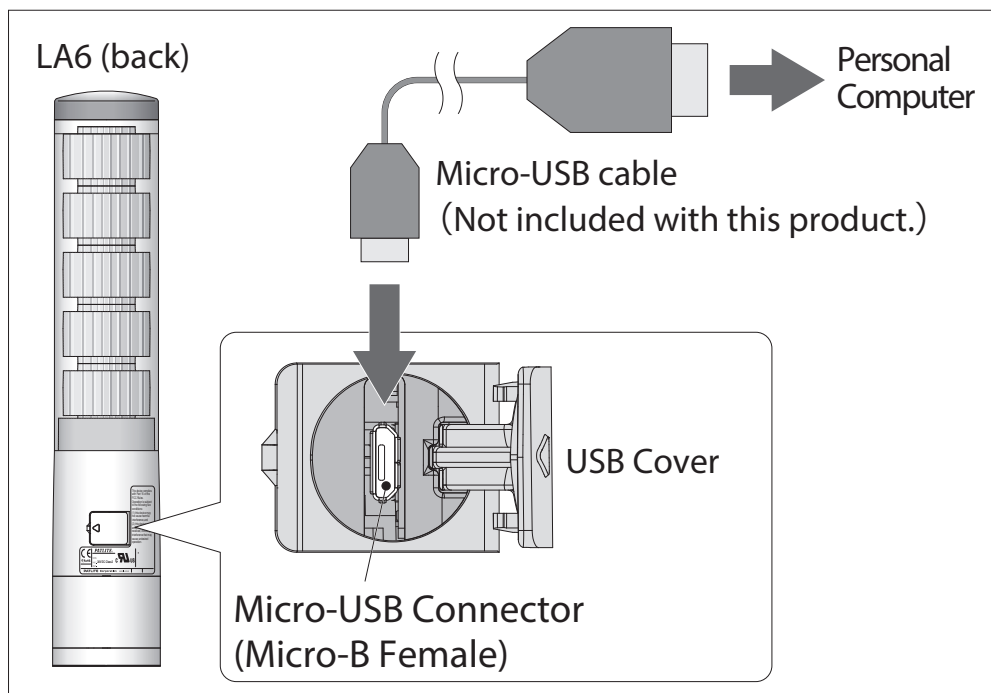

⚠ WARNING

- When transferring data via USB connection, do not allow the supply voltage from this product to contact with the personal computer, or its peripheral devices. Failure to comply will result in product damage due to combustion or fire.
 - As an example, if the positive power terminal is connected to ground and the personal computer, FG (housing), which in turn, makes a connection with this product via the USB connection, it should not be grounded because of the reverse polarity. There are some personal computers which have the USB port connector and negative terminal of the personal computer in contact with the FG (housing). Personal computers with such USB connections made, should have the FG (housing) of the personal computer and the negative terminal of the USB port of the product connected. If the case is where the personal computer has the metal part as the positive grounding of the supplied power source to the product, the product will have a 24V potential applied to the negative terminal of the USB port of the product, thus will lead to damage of the product by burning.

Note

- If the power supply input to the product is set to ON, the group operation test can be checked by clicking the "preview" button in the "EDITOR for LA series" application software.

8. Time Chart

A signal input and its input signal recognition are determined based on the time chart shown below. This product is roughly classified into two input signals, as indicated from the following contents.

- Standard Input Signal: All input signals, except a trigger input, are level hold inputs.
- Trigger Input Signal: It is a one shot input. (Only for the "Pulse-trigger" mode)

Refer to "6. Operating Directions" on page 19 for details.

In addition, the signal input holding time (data lead time) of this product is common to all signal inputs (except for the Multi-function Button).

Data lead time is 60 milliseconds.

8.1. Basic Signal Input Time Chart

If an input signal status is maintained by the data lead time indicated for this product, the input status is decided inside the product.

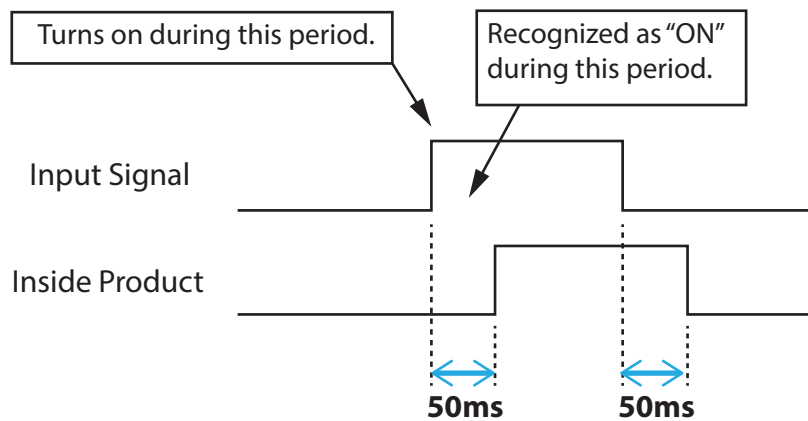

8.2. Trigger Input Signal Time Chart

Unlike other inputs, the trigger input in the "Smart Mode" turns into a one shot input. As the time in detection rises, and is maintained, the next detection is not recognized.

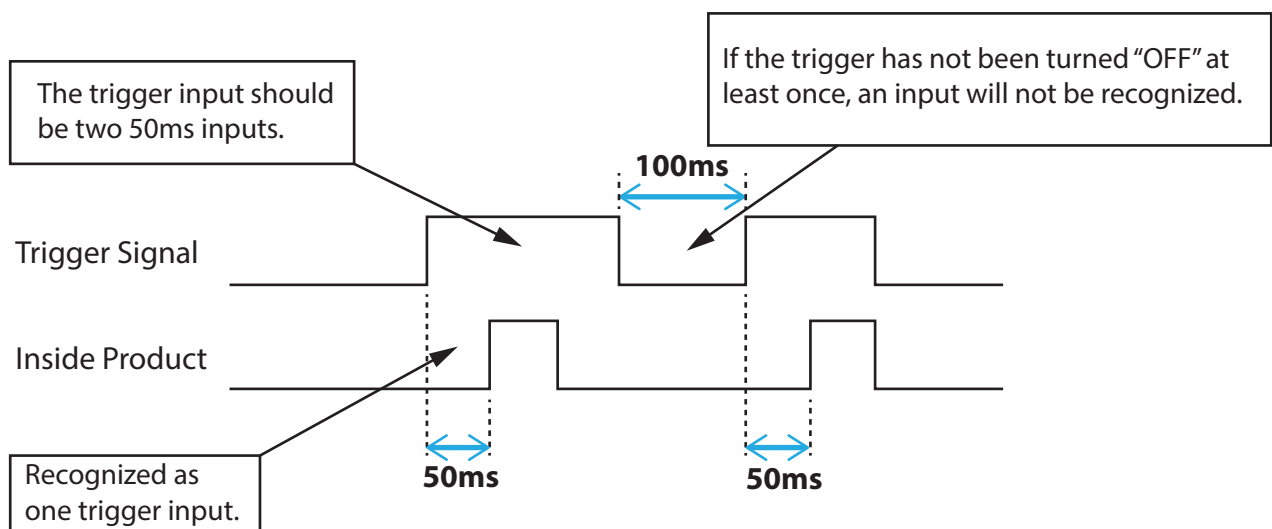

9. Before Requesting Repair

Even after proper installation, if it does not operate, please contact your nearest PATLITE Sales Representative or contact us with the information found on the last page of this book.

Problem	Where to Check	What to do
The LED does not light up.	Is the electric wiring connected correctly?	Refer to "5. Wiring" on page 13 for proper wiring.
A different LED tier from what I thought lights up when I make it turn on.	Is the electric wiring connected correctly?	Refer to "5. Wiring" on page 13 for proper wiring.
	Is the setup data correct?	Check the setup data contents.
The Alarm does not sound.	Is the electric wiring connected correctly?	Refer to "5. Wiring" on page 13 for proper wiring.
	Is the power properly supplying the correct voltage?	Check the rated supply voltage.
	Is the setup data correct?	Check the setup data contents.
	Check that the product type has a Alarm included or not.	The Alarm function is only included with products with a "B" in the part number.
The Alarm volume is small.	Is the Alarm volume set to minimum?	Refer to "6.3. Multi-function Button Operation" on page 26 on how to adjust the volume.
	Is the setup data correct?	Check the setup data contents.
The LED does not flash.	Is the electric wiring connected correctly?	Refer to "5. Wiring" on page 13 for proper wiring.
	Are the external contacts for lighting turning on?	Priority is given to the lighting input over the flashing input when simultaneous signals are applied.
	Check that the product type has a Alarm included or not.	The Alarm function is only included with products with a "B" in the part number.
	Is the setup data correct?	Check the setup data contents.
Cannot transfer data.	Is the proper type of cable being used?	Only use a cable which can charge and transfer data.

10. Replacement Parts

Several kinds of parts are available for the customer to change or replace.

Part Name	Part Number	Reference Figure
Head Cover (Off-white)	B31310001-7F1	
Head Cover (Silver)	B31310001-9F1	
USB Cover (Off-white)	B22100071-7F1	
USB Cover (Silver)	B22100071-9F1	
Waterproof Ring B (2 pc. Set)	B25110042-F1	
Pole Bracket Set (Pole Bracket, Pole Waterproofing Ring, Tapping screw (2 pc.) set)	B22210134-7F1	
Direct-mount Bracket (Off-white)	B22202027-9F1	
Direct-mount Bracket (Silver)		
Terminal Buss Bracket (Off-white)	B22202028-7F1	
Terminal Buss Bracket (Silver)	B22202028-9F1	
Pole Waterproofing Ring	B25110047-F1	

11. Specifications

Model		LA6-□D□□□□-□ (Refer to "2. Model Number Configuration" on page 5)					
Rated Voltage		DC24V			AC 100-240V (50/60Hz)		
Operating Voltage Range		±10% of Rated Voltage			AC 90-250V (50/60Hz)		
Rated Power Consumption	Standard	LA6-5D□□N-RYGBC	5W	LA6-5D□□B-RYGBC	6.5W	LA6-5D□□B-RYGBC	6.5W
		LA6-3D□□N-RYG	3.5W	LA6-3D□□B-RYG	4.5W		
	Maximum	LA6-5D N-YYYY	7W	LA6-5D□□B-YYYY	8W	LA6-3D□□B-YY	7.5W
		LA6-3D□□N-YYY	4.5W	LA6-3D□□B-YY	5.5W		
Environmental Condition		Alarm: Tone No.1 at Maximum Volume					
Signal Wire Current		Maximum 70mA			Maximum 20mA		
Standby Current		Maximum 15mA					
Standby Power Consumption		Maximum 0.6W					
Operating Ambient Temperature		-25°C - +60°C					
Operating Humidity Range		Less than 90% RH (No Dew or Condensation)					
Storage Temperature Range		-25°C - +60°C					
Storage Humidity Range		Less than 90% RH (No Dew or Condensation)					
Mounting Location		Indoor Only					
Mounting Direction		Upright/Inverted Direction					
Protection Rating		IP65 (Alarm specification: IP54) IEC 60529					
Environmental Condition		Upright Installation					
Vibration Resistance	LA6-□□LJ□□	Sweep Durability: Total amplitude: 0.3 mmp-p (10 - 57.5 Hz), Acceleration: 20.0 m/s ² (57.5 - 150 Hz) Fixed pitch durability: Acceleration 20.0 m/s ²					
	LA6-□□WJ□□ LA6-□□TN□□	Sweep Durability: Total amplitude 0.3 mmp-p (10 - 57.5 Hz), Acceleration: 20.0 m/s ² (57.5 - 150 Hz) Fixed Vibration Frequency Durability: Acceleration 10.0 m/s ²					
Environmental Condition		JIS C 60068-2-6:2010					
Insulation Resistance		More than 1Mohm at DC500V			More than 3Mohm at DC500V		
Withstand Voltage		500VAC for 1min			4000VAC for 1min		
Display Color (Typical Luminous Intensity)		red (1000 mcd) amber (1700 mcd) green (2600 mcd) blue (1000 mcd) white (1250 mcd)					
		purple (800 mcd) pink (850 mcd) sky blue (2150 mcd) lemon (2150 mcd)					
		* Due to the characteristics of the LED elements, a variation in difference of the color tone and brightness of every product may occur.					

LA6 Signal Tower Complete Operation Manual

Flash Rate	60 ± 2 fpm					
Alarm Sound (Typical Frequency)	No.1	2400Hz Continuous beep sound			No.2	2400Hz Rapid intermittent beep (0.05 sec. sound / 0.05 sec. silent)
	No.3	2400Hz Long intermittent beep (1.5 sec. sound / 1.5 sec. silent)			No.4	2400Hz Fast intermittent beep (0.5 sec. sound / 0.5 sec. silent)
	No.5	3600Hz Continuous beep Sound			No.6	3600Hz Rapid intermittent beep (0.05 sec. sound / 0.05 sec. silent)
	No.7	3600Hz Long intermittent beep (1.5 sec. sound / 1.5 sec. silent)			No.8	3600Hz Fast intermittent beep (0.5 sec. sound / 0.5 sec. silent)
	No.9	2400Hz & 3375Hz Multiplexed Beep (0.25 sec. / 0.25 sec.)			No.10	2400Hz & 3600Hz Multiplexed Beep (0.25 sec. / 0.25 sec.)
	No.11	4000Hz & 4800Hz Multiplexed Beep (0.25 sec. / 0.25 sec.)			-	
Sound Level	Maximum: 85dB					
Environmental Condition	Alarm Sound No.1 measured from the front direction of the Alarm opening at 1m					
Volume Control	The set up button is the fourth step (Factory Default: Maximum). [Maximum] -> [-5dB drop from maximum (standard)] -> [-10dB drop from maximum (standard)] -> [OFF] (-> Returns to [Maximum])					
Data Transfer Interface	Main Unit	USB micro-B Terminal Female USB2.0/1.1 Interface, Transmission Rate: USB2.0/1.1/1.0				
	Transfer Cable	Charge /Data Transfer compatible Micro-USB (not included) Connector Type: USB type Male to USB MicroB type Male				
Data Programming Application Software	Exclusive "EDITOR for LA series" Application Software (Downloadable from our Homepage)					
Mass (Tolerance 10%)	LA6-3DTN □ B	480g	LA6-3DLJ □ B	980g	LA6-5 AWJWB	740g
	LA6-3DTN □ N	420g	LA6-3DLJ □ N	930g		
	LA6-5 DTN □ B	590g	LA6-5 DLJ □ B	1090g		
	LA6-5 DTN □ N	530g	LA6-5 DLJ □ N	1040g		
Compliance Standards	EMC Directive (EN 61000-6-4, EN 61000-6-2)				RoHS Directive (EN 50581)	
	UL508, CSA-C22.2 No.14				KC (KN 61000-6-4, KN 61000-6-2)	
	FCC Part 15 Subpart B Class A				-	
Remarks	CE Marking Compliant					
	UL Recognized Component (File No.E215660)					

PATLITE Corporation G2J	
PATLITE Corporation ※Head office	■ www.patlite.com/
PATLITE (U.S.A.) Corporation	■ www.patlite.com/
PATLITE Europe GmbH ※Germany	■ www.patlite.eu/
PATLITE (SINGAPORE) PTE LTD	■ www.patlite-ap.com/
PATLITE (CHINA) Corporation	■ www.patlite.cn/
PATLITE KOREA CO., LTD.	■ www.patlite.co.kr/
PATLITE TAIWAN CO., LTD.	■ www.patlite.tw/
PATLITE (THAILAND) CO., LTD.	■ www.patlite.co.th/
PATLITE MEXICO S.A. de C.V.	■ www.patlite.com.mx/

- Specifications may change without notice due to continual product improvement.
- PATLITE and the PATLITE logo is a trademark, or registered trademark of the PATLITE Corporation of Japan and each country.
- Windows is a registered trademark of the U.S. Microsoft Corporation in the U.S. and other countries.